

Type:
Job:
Catalog number:

Approvals:

____ / ____ / ____ / ____
 Mtg. Fixture Electrical Module Finish Options
 See page 2 See pages 3-4

Date:
Page: 1 of 5

Select pole from Kim's Arms and Poles Selection Guide. If pole is provided by others indicate O.D. for arm fitting.

Specifications

WP9SE-LED
 Small Electronic
 60 Light Emitting Diodes
 Total Max System Watts = 73W
 Maximum weight: 30 lbs.

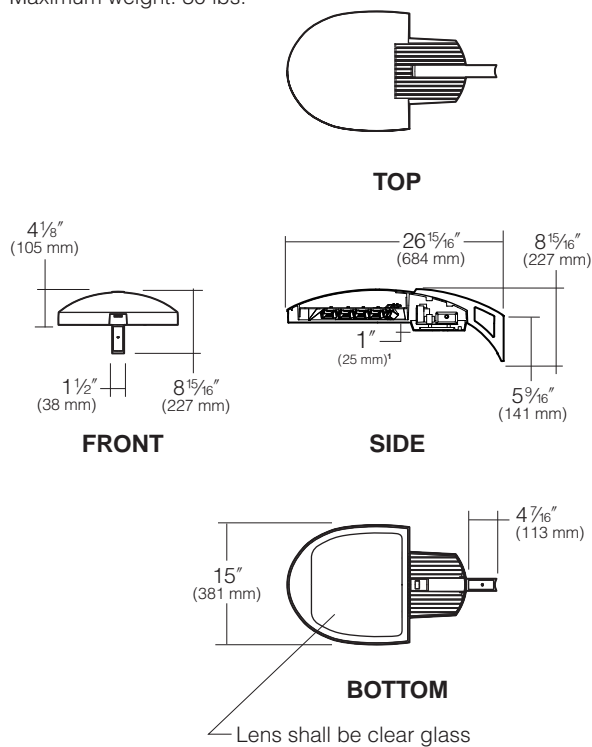

NOTE: Driver compartment door extends down 1" on small housing to accommodate integral step-down transformer on 347V and 480V models only.

Listings and Ratings			
UL cUL 1598 ²	CE	IP66 Rated	25°C Ambient

²Suitable for wet locations.
 KIM LIGHTING RESERVES THE RIGHT TO CHANGE SPECIFICATIONS WITHOUT NOTICE.



Housing: One-piece die-cast, low copper (<0.6% Cu) aluminum alloy with integral cooling ribs over the electrical compartment. Solid barrier wall separates optical and electrical compartments. A single die-cast aluminum cam-latch provides positive locking and sealing of the optical chamber. A one-piece extruded and vulcanized silicone gasket seals the housing against the lens surface.

Lens: Clear 3/16" thick tempered glass lens retained by a stainless steel piano hinge and a single die-cast aluminum cam-latch. The edges are camouflaged to conceal the outer portion of the housing.

Electronic Module: All electrical components are UL and CSA recognized, mounted on a single plate and factory prewired with quick-disconnect plugs. Module includes a driver, thermal control device and surge protector. Electrical module attaches to housing with no-tool hinges and latches, accessible by opening the lens frame only. Driver is rated for -40°F starting and has a 0-10V dimming interface for multi-level illumination options.

Optical Module: Precision, replaceable MicroEmitters are positioned to achieve directional control toward desired task. The entire EmitterDeck fastens to the housing as a one-piece module

Dimming: The WARP9 LED luminaire can be dimmed from 0% to 100% by the use of its standard 0-10v Interface driver. To activate the dimming system, a wiring harness is supplied and attached to the DIM Port (DIM IN) on the LifeShield Protection System. This port allows the 0-10v Interface to bypass the LifeShield and control the driver. The LifeShield works in conjunction with the control system to assure that overheating will not harm the LEDs. The wiring harness is connected with the use of the Purple lead as the positive (+) and the Grey lead as the negative (-) to an available control signal (by others).

Support Arm: Heavy cast, low copper aluminum alloy with stainless steel mounting bolts. A pole reinforcing plate is provided with wire strain relief. Arm is circular cut for specified round pole.

Finish: Super TGIC thermoset polyester powder coat paint, 2.5 mil nominal thickness, applied over a titanated zirconium conversion coating; 2500 hour salt spray test endurance rating. Standard colors are Black, Dark Bronze, Stealth Gray™, Platinum Silver, or White. Custom colors are available.

Warranty: Kim Lighting warrants Warp9 LED products ("Product(s)") sold by Kim Lighting to be free from defects in material and workmanship for (i) a period of five (5) years for metal parts, (ii) a period of ten (10) years for exterior housing paint finish(s), (iii) a period of six (6) years for LED Light Engines (MicroEmitters) and, (iv) a period of five (5) years for LED power components (LED Driver, LifeShield™ device, Surge Protector), from the date of sale of such goods to the buyer as specified in Kim Lighting shipment documents for each product.

CAUTION: Fixtures must be grounded in accordance with national, state and/or local electrical codes, Failure to do so may result in serious personal injury.

Type:
 Job:

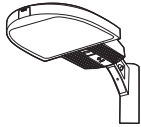

Standard Features

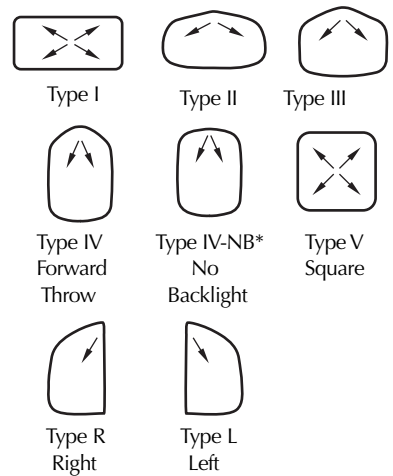
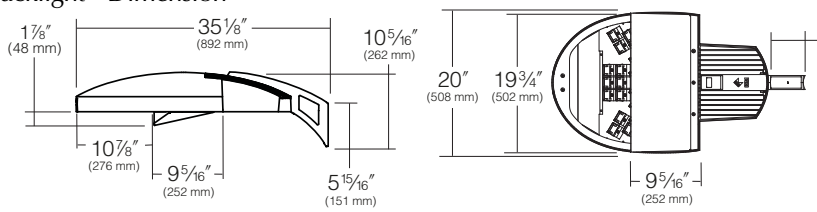
<p>Mounting 3Y configuration is available for round poles only.</p>	<p>Plan View:</p>  <p>EPA: 0.52 1.04 0.82 1.3 1.3 1.5 n/a Cat. No.: <input type="checkbox"/> 1SA <input type="checkbox"/> 2SB <input type="checkbox"/> 2SL <input type="checkbox"/> 3ST <input type="checkbox"/> 3SY <input type="checkbox"/> 4SC <input type="checkbox"/> 1W</p>																												
<p>Fixture Cat. No. designates fixture and light distribution. See the Kim Warp9 Catalog for detailed information on reflector design and application.</p>	<p>WP9 S E x</p> <p>Housing: WP9=WARP9</p> <p>Driver: E=Electronic</p> <p>Size: S=Small, 60 LEDs, 75W</p> <p>Distribution:</p> <ul style="list-style-type: none"> <input type="checkbox"/> 1=Type I Full Cutoff <input type="checkbox"/> 2=Type II Full Cutoff <input type="checkbox"/> 3=Type III Full Cutoff <input type="checkbox"/> 4=Type IV Full Cutoff <input type="checkbox"/> 4NB=Type IV-No Backlight <input type="checkbox"/> 5=Type V Square Full Cutoff <input type="checkbox"/> R=Type R Right Full Cutoff <input type="checkbox"/> L=Type L Left Full Cutoff <p>Light Distribution:</p>  <p>* Type IV-NB No Backlight - Dimension</p> 																												
<p>Electrical Module</p> <p>²Due to current unavailability of 347V and 480V drivers, specification of these voltages may feature an integral step-down transformer. Driver compartment door extends down 1" on small housing to accommodate transformer.</p>	<p>60 LxK x</p> <p>Source: 60 = 60 LED's</p> <p>Color Temperature:¹</p> <ul style="list-style-type: none"> <input type="checkbox"/> L3K=3500K <input type="checkbox"/> L5K=5100K <input type="checkbox"/> L2K = 580nm - Amber <p>¹4300K and 6500K are also available on an "Engineered-to-Order" (ETO) basis.</p> <p>Voltage:</p> <ul style="list-style-type: none"> <input type="checkbox"/> 120=120V <input type="checkbox"/> 208=208V <input type="checkbox"/> 240=240V <input type="checkbox"/> 277=277V <input type="checkbox"/> 347=347V² <input type="checkbox"/> 480=480V² <table border="1" data-bbox="495 1795 1526 1963"> <thead> <tr> <th>Fixture</th> <th>Total System Watts</th> <th>Volt</th> <th>Operating Amps</th> </tr> </thead> <tbody> <tr> <td>WP9-Small</td> <td>73</td> <td>120</td> <td>0.61</td> </tr> <tr> <td>WP9-Small</td> <td>73</td> <td>208</td> <td>0.35</td> </tr> <tr> <td>WP9-Small</td> <td>73</td> <td>240</td> <td>0.30</td> </tr> <tr> <td>WP9-Small</td> <td>73</td> <td>277</td> <td>0.26</td> </tr> <tr> <td>WP9-Small</td> <td>73</td> <td>347</td> <td>0.21</td> </tr> <tr> <td>WP9-Small</td> <td>73</td> <td>480</td> <td>0.15</td> </tr> </tbody> </table>	Fixture	Total System Watts	Volt	Operating Amps	WP9-Small	73	120	0.61	WP9-Small	73	208	0.35	WP9-Small	73	240	0.30	WP9-Small	73	277	0.26	WP9-Small	73	347	0.21	WP9-Small	73	480	0.15
Fixture	Total System Watts	Volt	Operating Amps																										
WP9-Small	73	120	0.61																										
WP9-Small	73	208	0.35																										
WP9-Small	73	240	0.30																										
WP9-Small	73	277	0.26																										
WP9-Small	73	347	0.21																										
WP9-Small	73	480	0.15																										

Type:

Job:

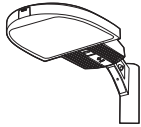



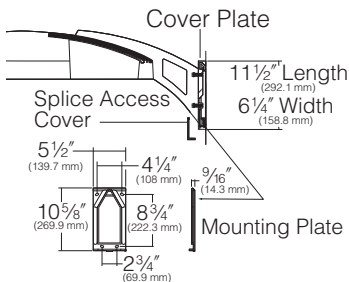
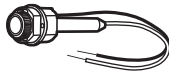
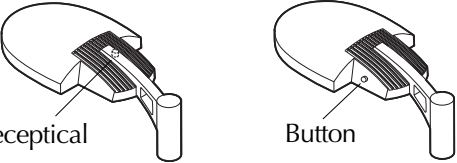
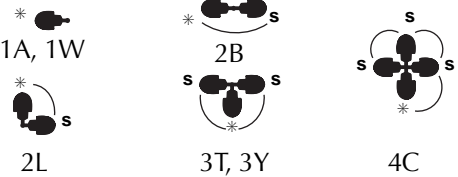
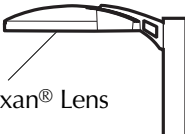
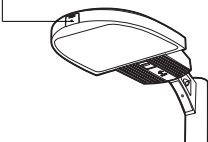

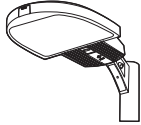

Optional Features

<p>Finish Super TGIC powder coat paint over a titanated zirconium conversion coating.</p>	<p>Color: Black Dark Bronze Stealth Gray™ Platinum Silver White Custom Color² Cat. No.: <input type="checkbox"/> BL <input type="checkbox"/> DB <input type="checkbox"/> SG <input type="checkbox"/> PS <input type="checkbox"/> WH <input type="checkbox"/> CC</p> <p>²Custom colors subject to additional charges, minimum quantities and extended lead times. Consult representative. Custom color description: _____</p>
<p>Wall Mounting Cat. No. 1W Select from Mounting on page 2.</p>	<p>A cast aluminum mounting plate is mounted to the wall with four bolts (by others). Fixture and arm are mounted to the cast aluminum cover plate before attaching to the wall mounting plate. The fixture-arm-cover plate assembly is hooked to the wall mounting plate and secured with stainless steel screws provided. Field splices are made at the opening in the cover plate. Cover is finished to match arm and fixture color.</p> 
<p>Fusing (internal only): Cat. No. (see chart at right) <input type="checkbox"/> No Option</p>	<p>High temperature fuse holders factory installed inside the fixture housing. Fuse is included.</p> <p>Line Volts: 120V 208V 240V 277V 347V 480V Cat. No.: <input type="checkbox"/> SF <input type="checkbox"/> DF <input type="checkbox"/> DF <input type="checkbox"/> SF <input type="checkbox"/> SF <input type="checkbox"/> DF</p>  <p>Single Fuse</p>
<p>Photocell Controls Cat. Nos. <i>receptacle</i> <input type="checkbox"/> A-25 <i>Line Button Volts</i> <input type="checkbox"/> A-30 - 120V <input type="checkbox"/> A-31 - 208V <input type="checkbox"/> A-32 - 240V <input type="checkbox"/> A-33 - 277V <input type="checkbox"/> A-35 - 347V <input type="checkbox"/> A-34 - 480V <input type="checkbox"/> No Option</p>	<p>Two types of photocell controls are available. A receptacle for a NEMA base photocell or an internal photocell button sensor on the side of the fixture.</p>  <p>Receptacle Button</p> <p>Mounting (see page 2)</p> <p>* - Fixture with Photocell Receptacle S - slave unit(s)</p> 
<p>Lexan® Lens Cat. No. <input type="checkbox"/> LS <input type="checkbox"/> No Option</p>	<p>One-piece flat advanced polymer (Lexan®) replaces standard tempered glass lens.</p> <p>CAUTION: Use only when vandalism is anticipated to be high. For LED use only.</p>  <p>Lexan® Lens</p>
<p>Tamper-Resistant Latch Cat. No. <input type="checkbox"/> TL <input type="checkbox"/> No Option</p>	<p>Standard die-cast latch is provided with a captive 10-32 stainless steel flat socket-head screw to prevent unauthorized opening.</p> <p>NOTE: Required only for vandal protection in locations where fixtures can be reached by unauthorized persons.</p>  <p>Tamper Resistant Latch</p>

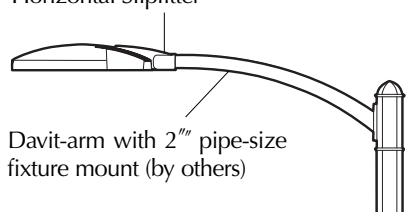
Type:
 Job:

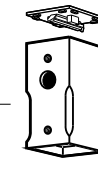

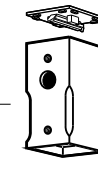
Optional Features

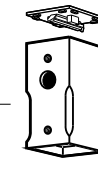
<p>Horizontal Slipfitter Mount Cat. No. <input type="checkbox"/> HSF <input type="checkbox"/> No Option</p>	<p>Replaces standard mounting arm with a cast aluminum fitter to adapt to a horizontal 2" pipe-size mounting end (2 3/8" OD). The casting has a 5° adjustment to accommodate davit arms that are not horizontal. Horizontal pipe must be field drilled at one set screw location to insure against fixture rotation Finish to match fixture color.</p>	<p>Horizontal Slipfitter</p>  <p>Davit-arm with 2" pipe-size fixture mount (by others)</p>						
<p>Vertical Slipfitter Mounts Cat. No. includes Mounting Cat. No. (See right) <input type="checkbox"/> No Option</p>	<p>Allows fixture or fixtures with standard mounting arm to mount to a pole with a 2" pipe-size tenon (2 3/8" OD). Minimum 4" tenon length required.</p> <p>Specify configuration (1SA, 2SB, 2SL, 3ST, 3SY, 4SC) 4" round or square aluminum with flush cap. Finish to match fixture and arm.</p> <p>NOTE: 3Y only available on round slipfitter.</p>	<table border="0"> <tr> <td data-bbox="487 1050 649 1260"> Cat. No. <input type="checkbox"/> VSF-1SA <input type="checkbox"/> VSF-2SB <input type="checkbox"/> VSF-2SL <input type="checkbox"/> VSF-3ST <input type="checkbox"/> VSF-3SY <input type="checkbox"/> VSF-4SC </td> <td data-bbox="649 1050 909 1260">  Round </td> <td data-bbox="763 1113 893 1197"> Stainless steel set screws </td> <td data-bbox="909 1050 1023 1260">  Square </td> <td data-bbox="1039 1050 1201 1260"> Cat. No. <input type="checkbox"/> SVSF-1SA <input type="checkbox"/> SVSF-2SB <input type="checkbox"/> SVSF-2SL <input type="checkbox"/> SVSF-3ST <input type="checkbox"/> SVSF-4SC </td> <td data-bbox="1234 1050 1526 1260"> Mounting Configuration 1SA -single arm mount 2SB -2 at 180° 2SL -2 at 90° 3ST -3 at 90° 3SY -3 at 120° 4SC -4 at 90° </td> </tr> </table>	Cat. No. <input type="checkbox"/> VSF-1SA <input type="checkbox"/> VSF-2SB <input type="checkbox"/> VSF-2SL <input type="checkbox"/> VSF-3ST <input type="checkbox"/> VSF-3SY <input type="checkbox"/> VSF-4SC	 Round	Stainless steel set screws	 Square	Cat. No. <input type="checkbox"/> SVSF-1SA <input type="checkbox"/> SVSF-2SB <input type="checkbox"/> SVSF-2SL <input type="checkbox"/> SVSF-3ST <input type="checkbox"/> SVSF-4SC	Mounting Configuration 1SA -single arm mount 2SB -2 at 180° 2SL -2 at 90° 3ST -3 at 90° 3SY -3 at 120° 4SC -4 at 90°
Cat. No. <input type="checkbox"/> VSF-1SA <input type="checkbox"/> VSF-2SB <input type="checkbox"/> VSF-2SL <input type="checkbox"/> VSF-3ST <input type="checkbox"/> VSF-3SY <input type="checkbox"/> VSF-4SC	 Round	Stainless steel set screws	 Square	Cat. No. <input type="checkbox"/> SVSF-1SA <input type="checkbox"/> SVSF-2SB <input type="checkbox"/> SVSF-2SL <input type="checkbox"/> SVSF-3ST <input type="checkbox"/> SVSF-4SC	Mounting Configuration 1SA -single arm mount 2SB -2 at 180° 2SL -2 at 90° 3ST -3 at 90° 3SY -3 at 120° 4SC -4 at 90°			
<p>Dimming Controls</p>	<p>Kim Lighting is working with several driver suppliers and control system manufacturers to develop a variety of proven turnkey solutions to meet any application's need. Kim Lighting will advise availability of complete control packages, and even two-way monitoring systems, once they have been tested and exceed Kim's high quality standards. Contact factory for further details and current capabilities.</p>							

Type:

Job:

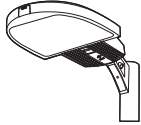

Lumen Performance Charts

NOTES:

1. Lumen loss stabilization is a result of Kim Lighting's MicroEmitter™ luminaires exclusive LifeShield™ Protection System and Dual Heat Management.
2. The LifeShield™ Protection System will lower the current to the LEDs significantly if the luminaire is exposed to direct heat (sun) or excessive abnormal conditions.
3. Luminaire Lumen Loss assumptions are based on LM-80 results and an actual outdoor product testing based upon 5100K CCT, 350mA drive current, 25°C/77°F tab ambient and cathode temperature at 85°C/185°F. Assumptions past 6,000 hours are interpolated.
4. Cathode temperature baseline is at 85°C/185°F. If cathode temperature increases during ambient changes and abnormal environment conditions, % of rated lumens will slightly decrease.
5. Outdoor ambient temperatures are assumed SITU average by geographic region.
6. As Solid State Lighting technology and thermal management systems continually advance, lumen loss projections are subject to improvement.

Luminaire Lumen Loss by Hours of Operation

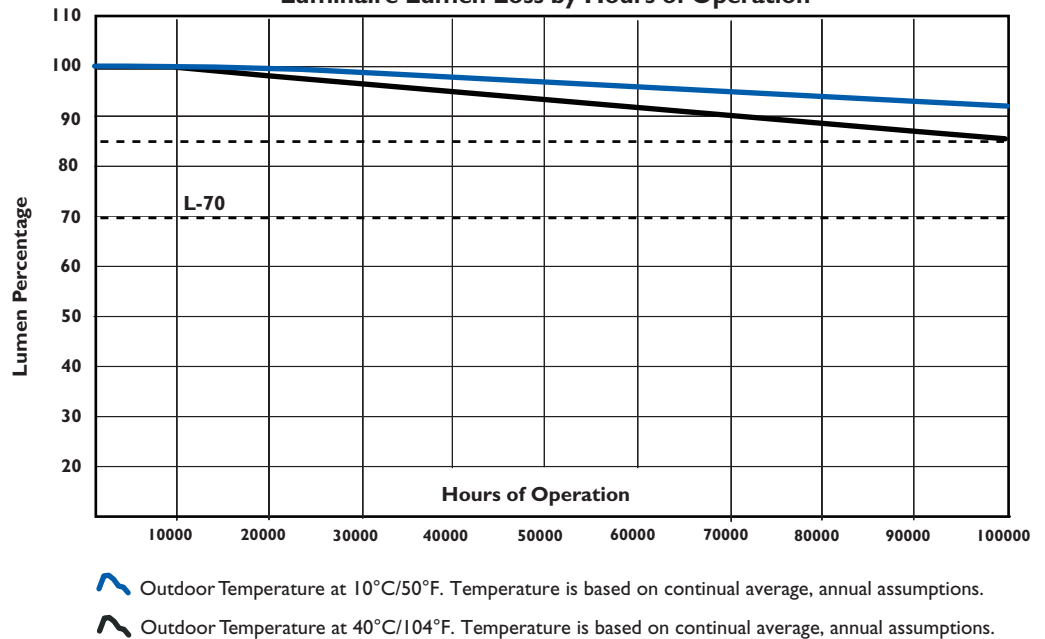

Luminaire Output at Outdoor Ambient Temperatures

