

Type:
Job:
Catalog number:

Approvals:

VRB1C	/	/	/	/
Fixture	Electrical Module	Top Cap Finish	Concrete Shaft Finish	Option

See page 2

Date:
Page: 1 of 3

Specifications

VRB Models
 70 to 100 watt
 Medium Base Lamps
 42 watt Compact Fluorescent

VRB1C - Single Function Luminaire (Concrete Shaft)
 Maximum weight: 115 lb

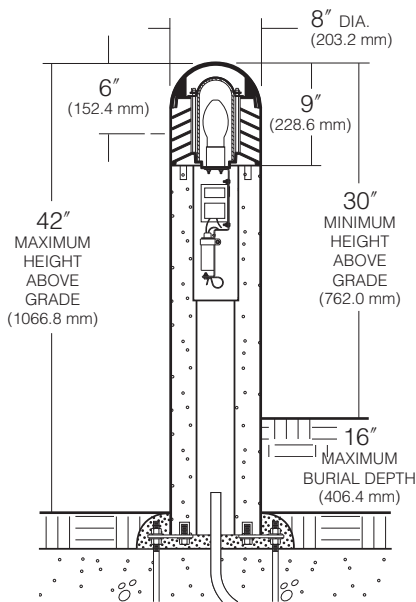

**BASE PLAN
 VRB
 CONCRETE SHAFT**

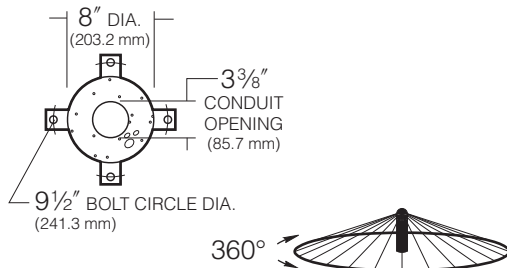

Domed Top Cap: One-piece die-cast aluminum $\frac{3}{16}$ " minimum thickness, secured to louvers by concealed allen screws in keyhole slots. For relamping access, allen screws shall not require complete removal.

Louvers: Aluminum die-cast with vertical support ribs at 90° intervals. Horizontal louver blades shall have a $1\frac{3}{4}$ " depth, a 65° upward pitch and provide light source cutoff above horizontal. Louver assembly shall be secured to shaft by four internal tie rods.

Lamp Enclosure: One-piece tempered molded glass with internal flutes and full gasketing at bottom edge.

Socket: Porcelain medium base socket rated 4KV for HID and incandescent. Plastic socket for Fluorescent.

Fixture Head: Allows flow-through ventilation around and above the lamp enclosure.

Ballast: Factory mounted to rigid harness for field wiring and suspension from fixture head within the concrete shaft. Wire leads supplied to base.

HID: High power factor with starting temperatures of -20°F. for PMH and -40°F. for HPS lamp modes. **26W, 32W, 42W Fluorescent:** High power factor with starting temperature of 0°F.

Anchor Bolts: Four $\frac{3}{8}$ " x 10" + 2" zinc plated L-hooks, each with two nuts, washers and a rigid pressed board template.

Material: Cement shall conform to current specifications for "Portland Cement." ASTM C150, Type I or II. Aggregates shall meet current requirements of "Specifications for Concrete Aggregates," ASTM C33. Water shall be clean and free from deleterious amounts of silt, oil, acids, alkalis or organic materials. Wire for reinforcement shall conform to ASTM A185. Steel for lugs and plates shall conform to ASTM A36, or A283 grade D.

Surface: Medium sand-blasted with anti-graffiti sealer. Available colors are Charcoal, Brown, Natural Gray or White, integral in concrete mix.

Cure and Strength: Allows for completion of the hydration process, and result in a 28 day compressive strength of not less than 4,500 psi.

Manufacture: Fiberglass molds used to insure uniform parts. Mold parting lines may be slightly visible in finished parts.

Anchorages: Four steel mounting tabs for installation on four $\frac{1}{2}$ " x 10" + 2" zinc electroplated L-hook anchor bolts. Each anchor bolt is supplied with two nuts, two washers, and a rigid pressed board template.

Shipment: Palletized with adequate hold-downs to prevent load movement in transit.

Finish: Super TGIC thermoset polyester powder coat paint, 2.5 mil nominal thickness, applied over a titanated zirconium conversion coating; 2500 hour salt spray test endurance rating. Standard colors are Black, Dark Bronze, Light Gray, Stealth Gray™, Platinum Silver, or White. Custom colors are available.

CAUTION: Fixtures must be grounded in accordance with national, state and/or local codes. Failure to do so may result in serious personal injury.

Listings and Ratings

UL cUL 1598 ¹	-	25C Ambient
IP46 Rated	FS = Fully Shielded ²	CE

¹Suitable for wet locations

²Dark Sky Legislation Compliant

KIM LIGHTING RESERVES THE RIGHT TO CHNGE SPECIFICATIONS WITHOUT NOTICE.



Type:

Job:

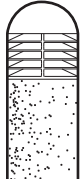
Page: 2 of 3

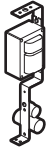

Standard and Optional Features

Fixture	Cat. No. VRB1C Single Function, Concrete Shaft, Domed Top																																																
Electrical Module PMH = Pulse Start Metal Halide HPS = High Pressure Sodium PL = Compact Fluorescent Lamp Watts Lamp Type Line Volts 100 PMH 120  <p>NOTE: For lamp/ballast information outside of the U.S.A. and Canada, please consult your local Kim representative.</p>	Cat. Nos. for Electrical Modules available: <table border="1" data-bbox="500 659 1459 974"> <tr> <td><input type="checkbox"/> 70PMH120</td> <td><input type="checkbox"/> 100PMH120</td> <td><input type="checkbox"/> 70HPS120</td> <td><input type="checkbox"/> 100HPS120</td> </tr> <tr> <td><input type="checkbox"/> 70PMH208</td> <td><input type="checkbox"/> 100PMH208</td> <td><input type="checkbox"/> 70HPS208</td> <td><input type="checkbox"/> 100HPS208</td> </tr> <tr> <td><input type="checkbox"/> 70PMH240</td> <td><input type="checkbox"/> 100PMH240</td> <td><input type="checkbox"/> 70HPS240</td> <td><input type="checkbox"/> 100HPS240</td> </tr> <tr> <td><input type="checkbox"/> 70PMH277</td> <td><input type="checkbox"/> 100PMH277</td> <td><input type="checkbox"/> 70HPS277</td> <td><input type="checkbox"/> 100HPS277</td> </tr> <tr> <td><input type="checkbox"/> 70PMH347</td> <td><input type="checkbox"/> 100PMH347</td> <td><input type="checkbox"/> 70HPS347</td> <td><input type="checkbox"/> 100HPS347</td> </tr> <tr> <td>Lamp</td> <td>E-17, Coated</td> <td>E-17, Coated</td> <td>ED-17, Coated</td> </tr> <tr> <td>Socket</td> <td>Medium Base</td> <td>Medium Base</td> <td>Medium Base</td> </tr> <tr> <td>ANSI Ballast Type</td> <td>M-98</td> <td>M-90</td> <td>S-62</td> </tr> <tr> <td></td> <td colspan="3"><input type="checkbox"/> 42PL¹</td> </tr> <tr> <td>Lamp</td> <td colspan="3">Compact Fluor.</td> </tr> <tr> <td>Socket</td> <td colspan="3">GX24q-4</td> </tr> </table> <p>NOTE: Coated lamps are recommended.</p>					<input type="checkbox"/> 70PMH120	<input type="checkbox"/> 100PMH120	<input type="checkbox"/> 70HPS120	<input type="checkbox"/> 100HPS120	<input type="checkbox"/> 70PMH208	<input type="checkbox"/> 100PMH208	<input type="checkbox"/> 70HPS208	<input type="checkbox"/> 100HPS208	<input type="checkbox"/> 70PMH240	<input type="checkbox"/> 100PMH240	<input type="checkbox"/> 70HPS240	<input type="checkbox"/> 100HPS240	<input type="checkbox"/> 70PMH277	<input type="checkbox"/> 100PMH277	<input type="checkbox"/> 70HPS277	<input type="checkbox"/> 100HPS277	<input type="checkbox"/> 70PMH347	<input type="checkbox"/> 100PMH347	<input type="checkbox"/> 70HPS347	<input type="checkbox"/> 100HPS347	Lamp	E-17, Coated	E-17, Coated	ED-17, Coated	Socket	Medium Base	Medium Base	Medium Base	ANSI Ballast Type	M-98	M-90	S-62		<input type="checkbox"/> 42PL ¹			Lamp	Compact Fluor.			Socket	GX24q-4		
<input type="checkbox"/> 70PMH120	<input type="checkbox"/> 100PMH120	<input type="checkbox"/> 70HPS120	<input type="checkbox"/> 100HPS120																																														
<input type="checkbox"/> 70PMH208	<input type="checkbox"/> 100PMH208	<input type="checkbox"/> 70HPS208	<input type="checkbox"/> 100HPS208																																														
<input type="checkbox"/> 70PMH240	<input type="checkbox"/> 100PMH240	<input type="checkbox"/> 70HPS240	<input type="checkbox"/> 100HPS240																																														
<input type="checkbox"/> 70PMH277	<input type="checkbox"/> 100PMH277	<input type="checkbox"/> 70HPS277	<input type="checkbox"/> 100HPS277																																														
<input type="checkbox"/> 70PMH347	<input type="checkbox"/> 100PMH347	<input type="checkbox"/> 70HPS347	<input type="checkbox"/> 100HPS347																																														
Lamp	E-17, Coated	E-17, Coated	ED-17, Coated																																														
Socket	Medium Base	Medium Base	Medium Base																																														
ANSI Ballast Type	M-98	M-90	S-62																																														
	<input type="checkbox"/> 42PL ¹																																																
Lamp	Compact Fluor.																																																
Socket	GX24q-4																																																
Finish Super TGIC thermoset polyester powder coat paint applied over a titanated titanium conversion coating on fixture top cap. Concrete shaft surface color is integral in concrete mix. Available in any combination of paint and concrete finishes listed at right.	Top Cap Color: Black Dark Bronze Light Gray Stealth Gray™ Platinum Silver White Custom Color ² Cat. No.: <input type="checkbox"/> BL <input type="checkbox"/> DB <input type="checkbox"/> LG <input type="checkbox"/> SG <input type="checkbox"/> PS <input type="checkbox"/> WH <input type="checkbox"/> CC Concrete Shaft Color: Brown Charcoal Natural Gray White Cat. No.: <input type="checkbox"/> BR-C <input type="checkbox"/> CH-C <input type="checkbox"/> NG-C <input type="checkbox"/> WH-C <p>NOTE: Black and Dark Bronze colors will produce slightly less louver brightness than Light Gray or White.</p> <p>²Custom colors subject to additional charges, minimum quantities and extended lead times. Available on fixture head only. Consult representative. Custom color description: _____</p>																																																
Optional Houseside Shield Cat. No. <input type="checkbox"/> HS <input type="checkbox"/> No Option	180° trimmable houseside shield that inserts inside lamp enclosure. .032" thick natural aluminum, trimmable in field.																																																
Optional Emergency Battery Back-up Cat. No. <input type="checkbox"/> EM <input type="checkbox"/> No Option	Internal battery pack provides 90 minutes of supplemental light at 23% of initial lamp lumens for 26, 32, or 42 watt compact fluorescent lamps.				 battery back-up																																												

Type:
 Job:

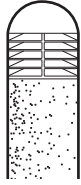

Standard and Optional Features

Cold-Pack Emergency Battery Pack

Cat. No. **EM-CP**
 No Option

The EM-CP option is a temperature controlled ballast designed to maintain operation without interruption within a range of hi/low ambient temperatures, -20°C to +55°C.

Internal Cold-Pack emergency battery pack provides up to 90 minutes of supplemental light. See following table for max. lumens output by lamps.



cold-pack
 battery back-up

Lamp (4-Pin)	1 lamp lumens
42W	750
32W	575
26W	450