



KIM LIGHTING

VRB1 Round Bollard

Single Function, Vandal-Resistant, Aluminum Shaft

revision 11/13/09 • vrb1.pdf

Type:
Job:
Catalog number:

Approvals:

VRB1	/	/	/
Fixture	Electrical Module	Luminaire Finish (includes top cap and shaft)	Option
See page 2			

Date:
Page: 1 of 3

Specifications

VRB Models

70 to 100 watt
Medium Base Lamps
42 watt Compact Fluorescent

VRB1 - Single Function Luminaire (Aluminum Shaft)

Maximum weight: 30 lb

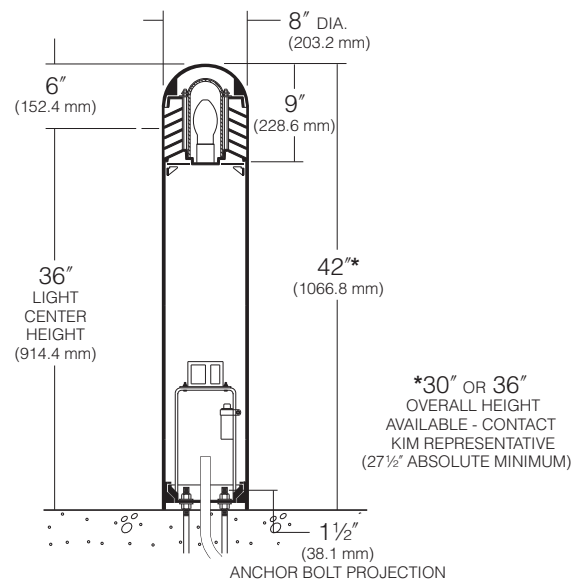

BASE PLAN VRB ALUMINUM SHAFT

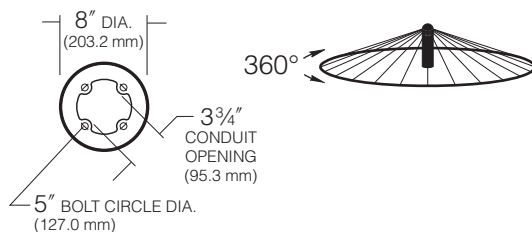

Domed Top Cap: One-piece die-cast aluminum secured to louvers by concealed allen screws in keyhole slots. For relamping access, allen screws shall not require complete removal.

Louvers: Aluminum die-cast with vertical support ribs at 90° intervals. Horizontal louver blades shall have a 1 3/4" depth, a 65° upward pitch and provide light source cutoff above horizontal. Louver assembly shall be secured to shaft by four internal tie rods.

Lamp Enclosure: One-piece tempered molded glass with internal flutes and full gasketing at bottom edge.

Socket: Porcelain medium base socket rated 4KV for HID and incandescent. Plastic socket for Fluorescent.

Fixture Head: Allows flow-through ventilation around and above the lamp enclosure.

Shaft: One-piece extruded aluminum, .125" wall thickness with a heavy cast aluminum twist-lock anchor base concealed within the shaft. Concealed set screws shall lock shaft onto the cast anchor base.

Ballast: Factory mounted to rigid harness attached to the anchor base. Wiring shall be supplied from the socket for field connection to the prewired ballast components. **HID:** High power factor with starting temperatures of -20°F. for PMH and -40°F. for HPS lamp modes. **26W, 32W, 42W Fluorescent:** High power factor with starting temperature of 0°F.

Anchor Bolts: Four 3/8" x 10" + 2" zinc plated L-hooks, each with two nuts, washers and a rigid pressed board template.

Finish: Super TGIC thermoset polyester powder coat paint, 2.5 mil nominal thickness, applied over a titanated zirconium conversion coating; 2500 hour salt spray test endurance rating. Standard colors are Black, Dark Bronze, Light Gray, Stealth Gray™, Platinum Silver, or White. Custom colors are available.

CAUTION: Fixtures must be grounded in accordance with national, state and/or local codes. Failure to do so may result in serious personal injury.

Listings and Ratings

UL cUL 1598 ¹	-	25C Ambient
IP46 Rated	FS = Fully Shielded ²	CE

¹Suitable for wet locations

²Dark Sky Legislation Compliant

KIM LIGHTING RESERVES THE RIGHT TO CHNGE SPECIFICATIONS WITHOUT NOTICE.





Type:

Job:

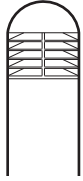
Page: 2 of 3

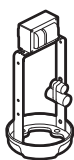

Standard and Optional Features

<p>Fixture</p>	Cat. No. VRB1 Single Function, Aluminum Shaft, Domed Top																																												
<p>Electrical Module PMH = Pulse Start Metal Halide HPS = High Pressure Sodium PL = Compact Fluorescent</p> <p>Lamp Watts Lamp Type Line Volts 100 PMH 120</p>  <p>NOTE: For lamp/ballast information outside of the U.S.A. and Canada, please consult your local Kim representative.</p>	<p>Cat. Nos. for Electrical Modules available:</p> <table border="1" data-bbox="500 703 1458 1039"> <tr> <td><input type="checkbox"/> 70PMH120</td> <td><input type="checkbox"/> 100PMH120</td> <td><input type="checkbox"/> 70HPS120</td> <td><input type="checkbox"/> 100HPS120</td> </tr> <tr> <td><input type="checkbox"/> 70PMH208</td> <td><input type="checkbox"/> 100PMH208</td> <td><input type="checkbox"/> 70HPS208</td> <td><input type="checkbox"/> 100HPS208</td> </tr> <tr> <td><input type="checkbox"/> 70PMH240</td> <td><input type="checkbox"/> 100PMH240</td> <td><input type="checkbox"/> 70HPS240</td> <td><input type="checkbox"/> 100HPS240</td> </tr> <tr> <td><input type="checkbox"/> 70PMH277</td> <td><input type="checkbox"/> 100PMH277</td> <td><input type="checkbox"/> 70HPS277</td> <td><input type="checkbox"/> 100HPS277</td> </tr> <tr> <td><input type="checkbox"/> 70PMH347</td> <td><input type="checkbox"/> 100PMH347</td> <td><input type="checkbox"/> 70HPS347</td> <td><input type="checkbox"/> 100HPS347</td> </tr> <tr> <td>Lamp</td> <td>E-17, Coated</td> <td>E-17, Coated</td> <td>ED-17, Coated</td> <td>ED-17, Coated</td> </tr> <tr> <td>Socket</td> <td>Medium Base</td> <td>Medium Base</td> <td>Medium Base</td> <td>Medium Base</td> </tr> <tr> <td>ANSI Ballast Type</td> <td>M-98</td> <td>M-90</td> <td>S-62</td> <td>S-54</td> </tr> </table> <table border="1" data-bbox="500 1071 844 1197"> <tr> <td><input type="checkbox"/> 42PL¹</td> </tr> <tr> <td>Lamp</td> <td>Compact Fluor.</td> </tr> <tr> <td>Socket</td> <td>GX24q-4</td> </tr> </table> <p>NOTE: ¹42PL operates one 26, 32, or 42 watt lamp at 120 thru 277 volts (50-60 Hz). NOTE: Coated lamps are recommended.</p>					<input type="checkbox"/> 70PMH120	<input type="checkbox"/> 100PMH120	<input type="checkbox"/> 70HPS120	<input type="checkbox"/> 100HPS120	<input type="checkbox"/> 70PMH208	<input type="checkbox"/> 100PMH208	<input type="checkbox"/> 70HPS208	<input type="checkbox"/> 100HPS208	<input type="checkbox"/> 70PMH240	<input type="checkbox"/> 100PMH240	<input type="checkbox"/> 70HPS240	<input type="checkbox"/> 100HPS240	<input type="checkbox"/> 70PMH277	<input type="checkbox"/> 100PMH277	<input type="checkbox"/> 70HPS277	<input type="checkbox"/> 100HPS277	<input type="checkbox"/> 70PMH347	<input type="checkbox"/> 100PMH347	<input type="checkbox"/> 70HPS347	<input type="checkbox"/> 100HPS347	Lamp	E-17, Coated	E-17, Coated	ED-17, Coated	ED-17, Coated	Socket	Medium Base	Medium Base	Medium Base	Medium Base	ANSI Ballast Type	M-98	M-90	S-62	S-54	<input type="checkbox"/> 42PL¹	Lamp	Compact Fluor.	Socket	GX24q-4
<input type="checkbox"/> 70PMH120	<input type="checkbox"/> 100PMH120	<input type="checkbox"/> 70HPS120	<input type="checkbox"/> 100HPS120																																										
<input type="checkbox"/> 70PMH208	<input type="checkbox"/> 100PMH208	<input type="checkbox"/> 70HPS208	<input type="checkbox"/> 100HPS208																																										
<input type="checkbox"/> 70PMH240	<input type="checkbox"/> 100PMH240	<input type="checkbox"/> 70HPS240	<input type="checkbox"/> 100HPS240																																										
<input type="checkbox"/> 70PMH277	<input type="checkbox"/> 100PMH277	<input type="checkbox"/> 70HPS277	<input type="checkbox"/> 100HPS277																																										
<input type="checkbox"/> 70PMH347	<input type="checkbox"/> 100PMH347	<input type="checkbox"/> 70HPS347	<input type="checkbox"/> 100HPS347																																										
Lamp	E-17, Coated	E-17, Coated	ED-17, Coated	ED-17, Coated																																									
Socket	Medium Base	Medium Base	Medium Base	Medium Base																																									
ANSI Ballast Type	M-98	M-90	S-62	S-54																																									
<input type="checkbox"/> 42PL¹																																													
Lamp	Compact Fluor.																																												
Socket	GX24q-4																																												
<p>Finish Super TGIC thermoset polyester powder coat paint applied over a titanated zirconium conversion coating on fixture and shaft.</p>	<p>Color: Black Dark Bronze Light Gray Stealth Gray™ Platinum Silver White Custom Color²</p> <p>Cat. No.: <input type="checkbox"/> BL <input type="checkbox"/> DB <input type="checkbox"/> LG <input type="checkbox"/> SG <input type="checkbox"/> PS <input type="checkbox"/> WH <input type="checkbox"/> CC</p> <p>NOTE: Black and Dark Bronze colors will produce slightly less louver brightness than Light Gray or White. ²Custom colors subject to additional charges, minimum quantities and extended lead times. Consult representative. Custom color description: _____</p>																																												
<p>Optional Houseside Shield Cat. No. <input type="checkbox"/> HS <input type="checkbox"/> No Option</p>	<p>180° trimmable houseside shield that inserts inside lamp enclosure. .032" thick natural aluminum, trimmable in field.</p> 																																												
<p>Optional Emergency Battery Back-up Cat. No. <input type="checkbox"/> EM <input type="checkbox"/> No Option</p>	<p>Internal battery pack provides 90 minutes of supplemental light at 23% of initial lamp lumens for 26, 32, or 42 watt compact fluorescent lamps.</p>  <p>battery back-up</p>																																												

Type:
 Job:

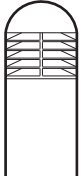

Standard and Optional Features

Cold-Pack Emergency Battery Pack

Cat. No. **EM-CP**
 No Option

The EM-CP option is a temperature controlled ballast designed to maintain operation without interruption within a range of hi/low ambient temperatures, -20°C to +55°C.

Internal Cold-Pack emergency battery pack provides up to 90 minutes of supplemental light. See following table for max. lumens output by lamps.

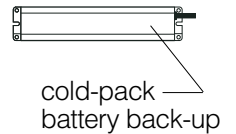

<u>Lamp (4-Pin)</u>	<u>1 lamp lumens</u>
42W	750
32W	575
26W	450