

**Type:**  
**Job:**  
**Catalog number:**

**Approvals:**

/                      /                      /                      /  
 Mtg.    Fixture                      Electrical Module                      Finish                      Options  
 \_\_\_\_\_ See page 2                      \_\_\_\_\_ See page 3                      \_\_\_\_\_ See pages 4-5

**Date:**  
**Page: 1 of 5**

Select pole from Kim Arms and Poles Selection Guide. If pole is provided by others indicate O.D. for arm fitting.

## Specifications

29" Diameter  
750-1000 Watt

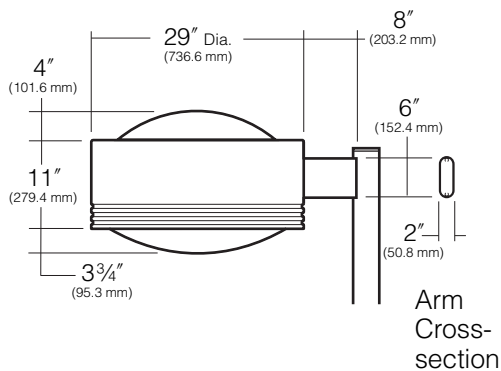

**Housing:** Spun aluminum with integral top dome and three equally spaced rollformed reveals, 1/2" wide, separated by 1/2" ribs, 1/4" deep. Sidewalls have a maximum 1° of taper, and are free of welds or fasteners. A rollformed aluminum flange is hemmed into the bottom providing support for the reflector module. An internal aluminum casting provides for mounting of the electrical module and support for the housing hinge.

**Lens Frame Assembly:** One-piece cast aluminum lens frame is attached to the housing by a zinc plated cold rolled steel hinge with a stainless steel pin. Closure is by four self-retained stainless steel screws. A zinc plated steel self-locking stop-arm is provided to hold the lens frame or housing in the open position while servicing. A 3/16" thick clear tempered sag-glass lens is fully gasketed by a one-piece extruded and vulcanized silicone gasket. Lens is retained in the lens frame by zinc plated steel clips.

**Arm Mounting:** Arm is one-piece extruded aluminum with internal bolt guides and fully radiussed top and bottom. Luminaire-to-pole attachment is by internal draw bolts, and includes a pole reinforcing plate with wire strain relief. Arm is circular cut to mate with specified round pole.

**Reflector Module:** Specular Alzak® optical segments are rigidly mounted within a die-cast aluminum enclosure that attaches to the housing as a one-piece module. Reflectors are field rotatable in 90° increments. All sockets are factory prewired with a quick-disconnect plug for the ballast module. Wire penetrations to the socket are sealed by a silicone gasket to create a totally sealed optical chamber. The optical segments are positioned so that reflected light does not pass through the lamp arc tube. The socket is held in a heat sink die-cast segment and fastened to a multi-position plate set at the factory for "Wide" or "Medium" beam spread. The beam spread can be adjusted in the field with the simple removal of two screws and a turn of the socket brackets. "Narrow" beam reflectors are fixed and non-adjustable. All reflectors are equipped with a mogul base socket rated 5KV. All optical systems are interchangeable within the housing. 750, and 1000 watt vertical lamps utilize a lamp vibration stabilizer that braces the neck of the lamp with a two-prong stainless steel clamp extending from the socket mount.

**Electrical Module:** All electrical components are UL and CSA recognized, mounted on a single plate and factory prewired with quick-disconnect plugs. Module attaches inside housing using keyhole slots. All ballasts are high power factor with starting temperatures of -40°F. for HPS and -20°F. for PMH lamp modes.

**Finish:** Super TGIC thermoset polyester powder coat paint, 2.5 mil nominal thickness, applied over a titanated zirconium conversion coating; A.S.T. M. 2500 hour salt spray test endurance rating. Standard colors are Black, Dark Bronze, Light Gray, Stealth Gray™, Platinum Silver, or White. Custom colors are available.

**CAUTION:** Fixtures must be grounded in accordance with national, state and/or local electrical codes. Failure to do so may result in serious injury.

### Listings and Ratings

UL cUL 1598 <sup>1</sup>	CE	25C Ambient
	IP66 Rated	
(Full) Cut Off <sup>2</sup> (Flat Glass Lens Only)		

<sup>1</sup>Suitable for wet locations

<sup>2</sup>Dark Sky Legislation Compliant

KIM LIGHTING RESERVES THE RIGHT TO CHANGE SPECIFICATIONS WITHOUT NOTICE

Type:

Job:

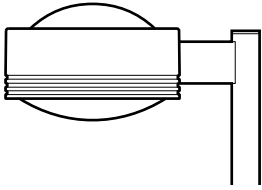

## Standard Features

### Mounting

3Y configuration is available for round poles or vertical slipfitter mount (VSF) only.

Plan View:

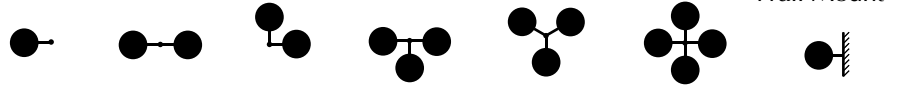

EPA:	1.8	3.6	3.3	5.2	5.2	5.9	—
Cat. No.:	<input type="checkbox"/> 1A	<input type="checkbox"/> 2B	<input type="checkbox"/> 2L	<input type="checkbox"/> 3T	<input type="checkbox"/> 3Y	<input type="checkbox"/> 4C	<input type="checkbox"/> 1W

### Fixture

Cat. No. designates VL fixture, light distribution and beam spread.

See the Kim Site/Roadway Optical Systems Catalog for detailed information on reflector design and application.

Convex Lens

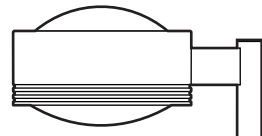

Light Distribution:  
Beam Spread:

Asymmetric  
Wide

Asymmetric  
Medium

Square  
Wide

Square  
Medium

Cat. No.:	<input type="checkbox"/> VLA29W3	<input type="checkbox"/> VLA29M3	<input type="checkbox"/> VLA29W5	<input type="checkbox"/> VLA29M5
-----------	----------------------------------	----------------------------------	----------------------------------	----------------------------------

Optional Flat Lens

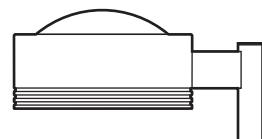

Light Distribution:  
Beam Spread:

Asymmetric  
Medium

Square  
Medium

Cat. No.:	<input type="checkbox"/> VLA29N3F <sup>1,2</sup>	<input type="checkbox"/> VLA29N5F <sup>1,2</sup>
-----------	--	--

#### NOTE:

<sup>1</sup>Flat Lens models must use ED37 lamps.

<sup>2</sup>All Flat Lens models are Full Cutoff, Narrow Distribution.

Type:

Job:

Page: 3 of 5

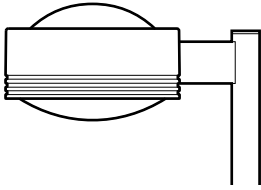

## Standard Features

### Electrical Module

**HPS** = High Pressure Sodium

**MH** = Metal Halide

**PMH** = Pulse Start Metal Halide

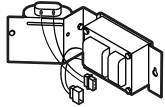

Lamp	Lamp	Line
Watts	Type	Volts
750	HPS	277

Cat. Nos. for Electrical Modules available:

	High Pressure Sodium		Metal Halide
	<input type="checkbox"/> 750HPS120	<input type="checkbox"/> 1000HPS120	<input type="checkbox"/> 1000MH120
	<input type="checkbox"/> 750HPS208	<input type="checkbox"/> 1000HPS208	<input type="checkbox"/> 1000MH208
	<input type="checkbox"/> 750HPS240	<input type="checkbox"/> 1000HPS240	<input type="checkbox"/> 1000MH240
	<input type="checkbox"/> 750HPS277	<input type="checkbox"/> 1000HPS277	<input type="checkbox"/> 1000MH277
	<input type="checkbox"/> 750HPS347	<input type="checkbox"/> 1000HPS347	<input type="checkbox"/> 1000MH347
	<input type="checkbox"/> 750HPS480	<input type="checkbox"/> 1000HPS480	<input type="checkbox"/> 1000MH480
Lamp	BT-37 Clear	E-25 Clear or ED-37 <sup>1</sup> Clear	BT-37 Clear
Socket	Mogul Base	Mogul Base	Mogul Base
ANSI Ballast Type	S-111	S-52	M-47

	Pulse Start Metal Halide	
	<input type="checkbox"/> 750PMH120	<input type="checkbox"/> 1000PMH120
	<input type="checkbox"/> 750PMH208	<input type="checkbox"/> 1000PMH208
	<input type="checkbox"/> 750PMH240	<input type="checkbox"/> 1000PMH240
	<input type="checkbox"/> 750PMH277	<input type="checkbox"/> 1000PMH277
	<input type="checkbox"/> 750PMH347	<input type="checkbox"/> 1000PMH347
	<input type="checkbox"/> 750PMH480	<input type="checkbox"/> 1000PMH480
Lamp	BT-37 Clear	BT-37 Clear
Socket	Mogul Base	Mogul Base
ANSI Ballast Type	M-149	M-141

<sup>1</sup>HPS Flat Lens models must use ED-37 lamps.

### Finish

Super TGIC powder coat paint over a titanated zirconium conversion coating.

Color: Black    Dark Bronze    Stealth Gray™    Platinum Silver    White    Custom Color<sup>2</sup>  
 Cat. No.:  **BL**     **DB**     **SG**     **PS**     **WH**     **CC**

<sup>2</sup>Custom colors subject to additional charges, minimum quantities and extended lead times. Consult representative. Custom color description: \_\_\_\_\_

Type:

Job:

Page: 4 of 5

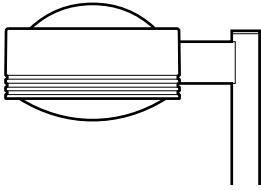

## Optional Features

### Wall Mounting

Cat. No. **1W**

Select from Mounting on page 2.

**Wall Mount:** A cast mounting plate of 356 alloy, low-copper (<0.6% Cu) aluminum, is mounted to the wall with bolts (by others). Fixture and arm are mounted to a cast 356 alloy aluminum cover plate before attaching to the wall mounting plate. The fixture-arm-cover plate assembly is hooked to the wall mounting plate, and secured with stainless steel screws provided. After mounting to the wall, field splices are made at the opening in the cover plate, then covered by a cast 356 alloy aluminum plate that blends with the cover plate design. Complete fixture-arm-cover plate assembly can therefore be mounted before field splices are made. Cover plate is finished to match arm and fixture powder coat color.

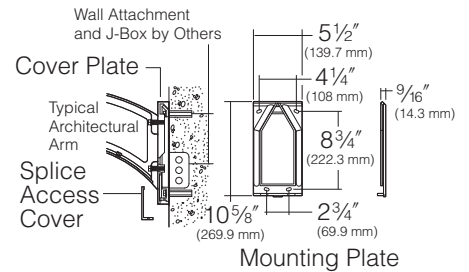

### Photocell

Cat. No. (See chart on right)  
 No Option

Factory installed photocell inside housing with a fully gasketed sensor on the side wall. 750 watt fixtures and above will have individual photocells.

Cat. No.	Line Volts:	Cat. No.	Line Volts:
<input type="checkbox"/> <b>A-30</b>	120V	<input type="checkbox"/> <b>A-33</b>	277V
<input type="checkbox"/> <b>A-31</b>	208V	<input type="checkbox"/> <b>A-35</b>	347V
<input type="checkbox"/> <b>A-32</b>	240V	<input type="checkbox"/> <b>A-34</b>	480V

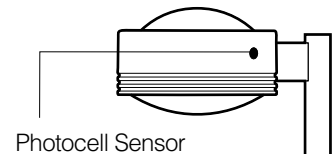

### Vertical Slipfitter Mount

Cat. No. includes Mounting.  
 Cat. No. (See chart on right)  
 No Option

Allows standard fixture and arm to be mounted to steel poles having a 2" pipe-size steel tenon (2 3/8" O.D. x 4 1/2" min. length). 4" round cast aluminum with flush cap, secured by four 3/8" stainless steel set point allen screws. Pole tenon must be field drilled at one set screw location to insure against fixture rotation. Finished to match fixture.

**NOTE:** 3Y only available on round slipfitter.

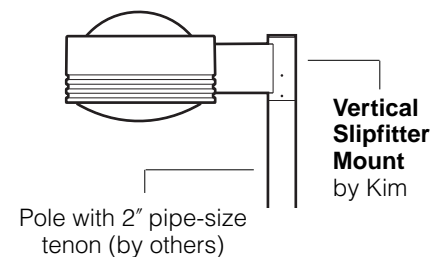

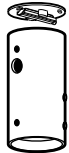
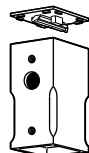
Cat. No.		Stainless steel set screws		Cat. No.	Mounting Configuration
<input type="checkbox"/> <b>VSF-1A</b>				<input type="checkbox"/> <b>SVSF-1A</b>	1A - Single arm mount
<input type="checkbox"/> <b>VSF-2B</b>				<input type="checkbox"/> <b>SVSF-2B</b>	2B - 2 at 180°
<input type="checkbox"/> <b>VSF-2L</b>				<input type="checkbox"/> <b>SVSF-2L</b>	2L - 2 at 90°
<input type="checkbox"/> <b>VSF-3T</b>				<input type="checkbox"/> <b>SVSF-3T</b>	3T - 3 at 90°
<input type="checkbox"/> <b>VSF-3Y</b>					3Y - 3 at 120°
<input type="checkbox"/> <b>VSF-4C</b>	4" Round			<input type="checkbox"/> <b>SVSF-4C</b>	4C - 4 at 90°

Type:

Job:

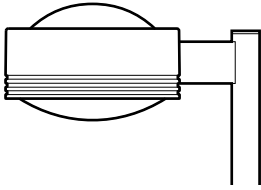

## Optional Features

### Horizontal Slipfitter Mount

Cat. No.  HSF  
 No Option

Replaces standard mounting arm with a slipfitter which allows VL Arm Mount model to be mounted to a horizontal pole davit-arm with 2" pipe-size mounting end (2<sup>3</sup>/<sub>8</sub>" O.D.). Cast aluminum clamp-type slipfitter with set screw anti-rotation lock. Bolts to housing from inside the electrical compartment using mounting holes for the standard support arm. Davit-arm must be field drilled at a set screw location to insure against fixture rotation. Finished to match fixture and arm.

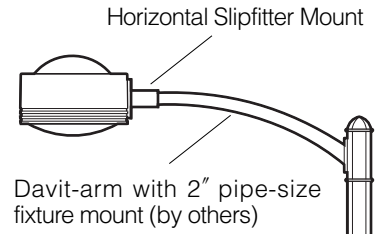

### Accent Reveals

Cat. No. **(See right)**  
 No Option

Three aluminum bands riveted inside the housing reveals. Available in five standard Kim powder coat finishes. Custom colors available. Super TGIC thermoset polyester powder coat paint, 2.5 mil nominal thickness, applied over a titanated zirconium conversion coating; A.S.T.M.2500 hour salt spray test endurance rating.

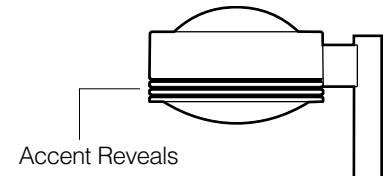

Color: Black Dark Bronze Light Gray Stealth Gray™ Platinum Silver White Custom Colors<sup>1</sup>

Cat. No.:  BL-REV  DB-REV  LG-REV  SG-REV  PS-REV  WH-REV  CC-REV

<sup>1</sup>Custom colors subject to additional charges, minimum quantities and extended lead times. Consult representative. Custom color description: \_\_\_\_\_