



KIM LIGHTING

VL 25" Post Top Mounted Vertical Lamp Luminaire

revision 10/1/08 • vl25p.pdf

Type:
Job:
Catalog number:

Approvals:

/	/	/	/
Mtg. Fixture	Electrical Module	Finish	Options
See page 2	See page 3		See page 4

Date:
Page: 1 of 4

Select pole from Kim Arms and Poles Selection Guide. If pole is provided by others indicate O.D. for arm fitting.

Specifications

25" Diameter
150-400 Watt

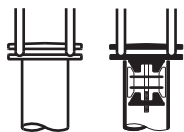
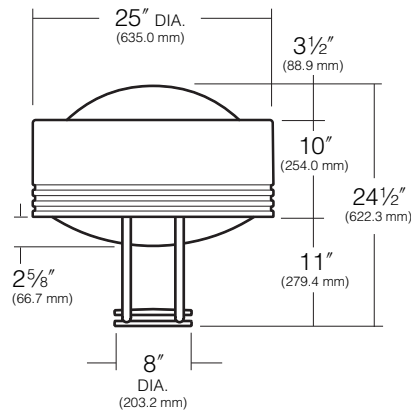

Flush Mount (FM)

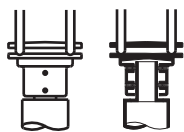

Post Top Mount (PT)

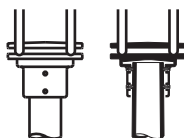

Direct Mount (DM)

Housing: Spun aluminum with integral top dome and three equally spaced rollformed reveals, 1/2" wide, separated by 1/2" ribs, 1/4" deep. Sidewalls have a maximum 1° of taper, and are free of welds or fasteners. A rollformed aluminum flange is hemmed into the bottom providing support for the reflector module. An internal aluminum casting provides for mounting of the electrical module and support for the housing hinge.

Lens Frame and Yoke: One-piece cast aluminum lens frame is attached to the housing by a zinc plated cold rolled steel hinge with a stainless steel pin. Closure of the housing is by four self-retained stainless steel screws. A stainless steel self-locking stop arm is provided to hold the housing in the open position while servicing. A 3/16" thick clear flat tempered glass lens is fully gasketed by a one-piece extruded and vulcanized silicone gasket. Lens is retained in the frame by removable zinc plated steel clips. Lens frame is supported at four points by two aluminum U-shaped tubular arms cradled in a cast aluminum hub. Arms are welded to the lens frame, and welded to the hub along their longitudinal axis. Hub contains a field-splice compartment, a cast aluminum cover and one of the following pole attachment means:

FM - Flush Mounting by means of an expansion device activated by a single bolt within the splice compartment. Pole must have a plain-cut top.

PT - Pole Tenon mounting by means of a cast aluminum extension sleeve containing four recessed 3/8" stainless steel allen head set point screws. Pole must have a 2" pipe-size tenon (2 3/8" O.D. x 4 3/4" minimum length). Pole tenon must be field drilled at one set screw location to secure against fixture rotation.

DM - Direct Mounting by means of a cast aluminum extension sleeve containing four recessed 3/8" stainless steel allen head set point screws. Pole must have a plain-cut top, 3.1" to 3.9" diameter. Pole must be field-drilled at one set screw location to secure against fixture rotation.

Reflector Module: Specular Alzak® optical segments are rigidly mounted within a die-cast aluminum enclosure that attaches to the housing as a one-piece module. Reflectors are field rotatable in 90° increments. All sockets are factory prewired with a quick-disconnect plug for the ballast module. Wire penetrations to the socket are sealed by a silicone gasket to create a totally sealed optical chamber. The optical segments are positioned so that reflected light does not pass through the lamp arc tube. The socket is held in a heat sink die-cast segment and fastened to a multi-position plate set at the factory for "Wide" or "Medium" beam spread. The beam spread can be adjusted in the field with the simple removal of two screws and a turn of the socket brackets. "Narrow" beam reflectors are fixed and non-adjustable. All reflectors are equipped with a mogul base socket rated 4KV. All optical systems are interchangeable within the housing. 400 watt vertical lamps utilize a lamp vibration stabilizer that braces the neck of the lamp with two-prong stainless steel clamp extending from the socket mount.

Electrical Module: All electrical components are UL and CSA recognized mounted on a single plate and factory prewired with quick-disconnect plugs. Module attaches inside housing using keyhole slots. All ballasts are high power factor with starting temperatures of -40°F. for HPS and -20°F. for PMH lamp modes.

Finish: Super TGIC thermoset polyester powder coat paint, 2.5 mil nominal thickness, applied over a titanated zirconium conversion coating; A.S.T.M. 2500 hour salt spray test endurance rating. Standard colors are Black, Dark Bronze, Light Gray, Stealth Gray™, Platinum Silver, or White. Custom colors are available.

CAUTION: Fixtures must be grounded in accordance with national, state and/or local electrical codes. Failure to do so may result in serious injury.

Listings and Ratings

UL cUL 1598 ¹	CE	25C Ambient
	IP66 Rated	
(Full) Cut Off ² (Flat Glass Lens Only)		

¹Suitable for wet locations

²Dark Sky Legislation Compliant

KIM LIGHTING RESERVES THE RIGHT TO CHANGE SPECIFICATIONS WITHOUT NOTICE







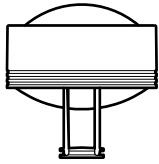

U.S. Patent: D358,898

Type:

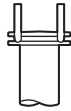
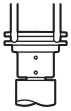
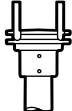
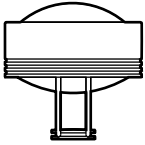
Job:

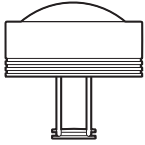

Standard Features

Mounting				
	EPA: 1.2	1.2	1.2	
	Cat. No.: <input type="checkbox"/> FM Flush Mount	<input type="checkbox"/> PT Pole Tenon Mount	<input type="checkbox"/> DM Direct Mount	
Pole Top Requirements:	4", 4½", 5", or 6" Dia.	2" Pipe-size Tenon (2⅜" O.D. x 4¾" L)	3.1" to 3.9" Dia.	
Fixture Cat. No. designates VL fixture, light distribution and beam spread. See the Kim Site/Roadway Optical Systems Catalog for detailed information on reflector design and application.	Convex Lens			
				
Light Distribution: Beam Spread:	Asymmetric Wide	Asymmetric Medium	Square Wide	Square Medium
Cat. No.:	<input type="checkbox"/> VLP25W3	<input type="checkbox"/> VLP25M3	<input type="checkbox"/> VLP25W5	<input type="checkbox"/> VLP25M5
Optional Flat Lens				
				
Light Distribution: Beam Spread:	Asymmetric Medium		Square Medium	
Cat. No.:	<input type="checkbox"/> VLP25N3F ^{1,2}		<input type="checkbox"/> VLP25N5F ^{1,2}	
NOTE: ¹ Flat Lens models must use ED-28 or BT-28 lamps. ² All Flat Lens models are Full Cutoff, Narrow Distribution.				

Type:

Job:

Page: 3 of 4

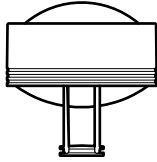

Standard Features

Electrical Module

HPS = High Pressure Sodium

PMH = Pulse Start Metal Halide

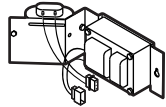

Lamp Watts	Lamp Type	Line Volts
400	HPS	277

Cat. Nos. for Electrical Modules available:

High Pressure Sodium

<input type="checkbox"/> 150HPS120	<input type="checkbox"/> 250HPS120	<input type="checkbox"/> 400HPS120
<input type="checkbox"/> 150HPS208	<input type="checkbox"/> 250HPS208	<input type="checkbox"/> 400HPS208
<input type="checkbox"/> 150HPS240	<input type="checkbox"/> 250HPS240	<input type="checkbox"/> 400HPS240
<input type="checkbox"/> 150HPS277	<input type="checkbox"/> 250HPS277	<input type="checkbox"/> 400HPS277
<input type="checkbox"/> 150HPS347	<input type="checkbox"/> 250HPS347	<input type="checkbox"/> 400HPS347
<input type="checkbox"/> 150HPS480	<input type="checkbox"/> 250HPS480	<input type="checkbox"/> 400HPS480

Lamp	E-23½ Clear	ED-18 or ET-18 Clear	ED-18 or ET-18 Clear
Socket	Mogul Base	Mogul Base	Mogul Base
ANSI Ballast	S-55	S-50	S-51

Pulse Start Metal Halide

<input type="checkbox"/> 175PMH120	<input type="checkbox"/> 250PMH120	<input type="checkbox"/> 400PMH120 ^{1,2}
<input type="checkbox"/> 175PMH208	<input type="checkbox"/> 250PMH208	<input type="checkbox"/> 400PMH208 ^{1,2}
<input type="checkbox"/> 175PMH240	<input type="checkbox"/> 250PMH240	<input type="checkbox"/> 400PMH240 ^{1,2}
<input type="checkbox"/> 175PMH277	<input type="checkbox"/> 250PMH277	<input type="checkbox"/> 400PMH277 ^{1,2}
<input type="checkbox"/> 175PMH347	<input type="checkbox"/> 250PMH347	<input type="checkbox"/> 400PMH347 ^{1,2}
<input type="checkbox"/> 175PMH480	<input type="checkbox"/> 250PMH480	<input type="checkbox"/> 400PMH480 ^{1,2}

Lamp	BT-28 or ED-28 Clear	BT-28 or ED-28 Clear	BT-37 ¹ or ED-37 ¹ Clear or ED-28 ² Clear
Socket	Mogul Base	Mogul Base	Mogul Base
ANSI Ballast	M-137	M-138	M-135

¹400PMH Standard convex glass lens models must use BT-37 or ED-37 lamps.

²400PMH Flat Lens models must use BT-28 or ED-28 lamps.

NOTE: Due to the Energy Independence and Security Act (EISA) of 2007, Kim Lighting can no longer supply probe start metal halide ballasts with its luminaires, effective January 1, 2009. Contact Kim Lighting for availability of replacement ballasts for warranty service claims.

(Visit www.aboutlightingcontrols.org or the Library of Congress website for more details).

Finish

Super TGIC powder coat paint over a titanated zirconium conversion coating.

Color: Black Dark Bronze Stealth Gray™ Platinum Silver White Custom Color³
 Cat. No.: **BL** **DB** **SG** **PS** **WH** **CC**

³Custom colors subject to additional charges, minimum quantities and extended lead times. Consult representative. Custom color description: _____

Type:
 Job:

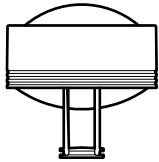

Optional Features

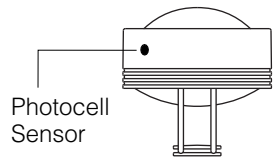
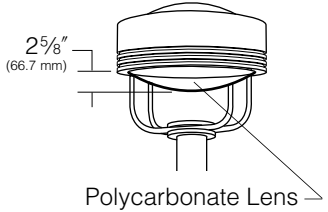
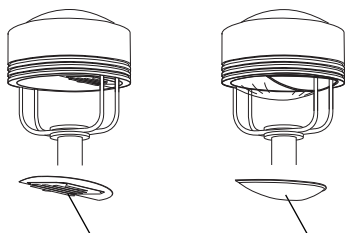
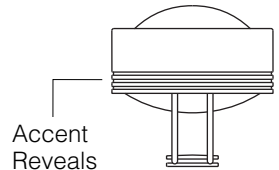
<p>Photocell Cat. No. (See chart on right) <input type="checkbox"/> No Option</p>	<p>Factory installed photocell in housing with fully gasketed sensor on side wall.</p> <table border="0"> <tr> <td>Cat. No.</td> <td>Line Volts:</td> <td>Cat. No.</td> <td>Line Volts:</td> </tr> <tr> <td><input type="checkbox"/> A-30</td> <td>120V</td> <td><input type="checkbox"/> A-33</td> <td>277V</td> </tr> <tr> <td><input type="checkbox"/> A-31</td> <td>208V</td> <td><input type="checkbox"/> A-35</td> <td>347V</td> </tr> <tr> <td><input type="checkbox"/> A-32</td> <td>240V</td> <td><input type="checkbox"/> A-34</td> <td>480V</td> </tr> </table>	Cat. No.	Line Volts:	Cat. No.	Line Volts:	<input type="checkbox"/> A-30	120V	<input type="checkbox"/> A-33	277V	<input type="checkbox"/> A-31	208V	<input type="checkbox"/> A-35	347V	<input type="checkbox"/> A-32	240V	<input type="checkbox"/> A-34	480V	 <p>Photocell Sensor</p>
Cat. No.	Line Volts:	Cat. No.	Line Volts:															
<input type="checkbox"/> A-30	120V	<input type="checkbox"/> A-33	277V															
<input type="checkbox"/> A-31	208V	<input type="checkbox"/> A-35	347V															
<input type="checkbox"/> A-32	240V	<input type="checkbox"/> A-34	480V															
<p>Polycarbonate Lens Cat. No. <input type="checkbox"/> L25 <input type="checkbox"/> No Option</p>	<p>Clear UV stabilized convex polycarbonate replaces standard tempered glass lens, gasketed and integral with lens frame. 250 watt maximum. 400 Watt HPS is allowable in locations where ambient air temperature will not exceed 85° F. during operation.</p> <p>CAUTION: Use only when vandalism is anticipated to be high. Useful life is limited by UV discoloration from sunlight and metal halide lamps.</p>	 <p>2 5/8" (66.7 mm) Polycarbonate Lens</p>																
<p>Houseside Shield Cat. No. <input type="checkbox"/> No Option</p>	<p>Fixtures with the standard convex glass lens or polycarbonate lens are available with a formed aluminum shield that passes streetside light and blocks houseside light, and a black anodized panel added to the reflector to reduce houseside reflections.</p> <p>Fixtures with the optional flat glass lens are available with stamped aluminum louvers that pass streetside light and block houseside light, and a blackened panel added to the reflector to reduce houseside reflections.</p> <p>Note: Recommended for use with clear lamps only.</p> <p>Cat. No.</p> <p><input type="checkbox"/> HS For fixtures with optional flat glass lens. For use with asymmetric distribution only.</p> <p><input type="checkbox"/> HSC For use with asymmetric distributions only. For fixtures with standard convex glass lens or optional polycarbonate lens.</p>	 <p>HS for flat lens HSC for convex lens or polycarbonate lens</p>																
<p>Accent Reveals Cat. No. (See right) <input type="checkbox"/> No Option</p>	<p>Three aluminum bands riveted inside the housing reveals. Available in five standard Kim powder coat finishes. Custom colors available. Super TGIC thermoset polyester powder coat paint, 2.5 mil nominal thickness, applied over a titanated zirconium conversion coating; A.S.T.M. 2500 hour salt spray test endurance rating.</p> <table border="0"> <tr> <td>Color:</td> <td>Black</td> <td>Dark Bronze</td> <td>Light Gray</td> <td>Stealth Gray™</td> <td>Platinum Silver</td> <td>White</td> <td>Custom Colors¹</td> </tr> <tr> <td>Cat. No.:</td> <td><input type="checkbox"/> BL-REV</td> <td><input type="checkbox"/> DB-REV</td> <td><input type="checkbox"/> LG-REV</td> <td><input type="checkbox"/> SG-REV</td> <td><input type="checkbox"/> PS-REV</td> <td><input type="checkbox"/> WH-REV</td> <td><input type="checkbox"/> CC-REV</td> </tr> </table> <p>¹Custom colors subject to additional charges, minimum quantities and extended lead times. Consult representative. Custom color description: _____</p>	Color:	Black	Dark Bronze	Light Gray	Stealth Gray™	Platinum Silver	White	Custom Colors ¹	Cat. No.:	<input type="checkbox"/> BL-REV	<input type="checkbox"/> DB-REV	<input type="checkbox"/> LG-REV	<input type="checkbox"/> SG-REV	<input type="checkbox"/> PS-REV	<input type="checkbox"/> WH-REV	<input type="checkbox"/> CC-REV	 <p>Accent Reveals</p>
Color:	Black	Dark Bronze	Light Gray	Stealth Gray™	Platinum Silver	White	Custom Colors ¹											
Cat. No.:	<input type="checkbox"/> BL-REV	<input type="checkbox"/> DB-REV	<input type="checkbox"/> LG-REV	<input type="checkbox"/> SG-REV	<input type="checkbox"/> PS-REV	<input type="checkbox"/> WH-REV	<input type="checkbox"/> CC-REV											