



KIM LIGHTING

VL 25" Arm Mounted Vertical Lamp Luminaire

revision 10/1/08 • vl25a.pdf

Type:
Job:
Catalog number:

Approvals:

____ /	____ /	____ /	____ /
Mtg. Fixture	Electrical Module	Finish	Options
See page 2	See page 3		See pages 4-5

Date:
Page: 1 of 5

Select pole from Kim Arms and Poles Selection Guide. If pole is provided by others indicate O.D. for arm fitting.

Specifications

25" Diameter
150-400 Watt

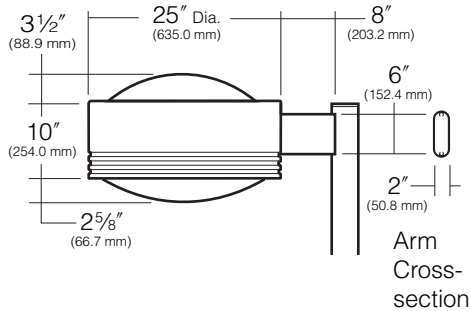

Housing: Spun aluminum with integral top dome and three equally spaced rollformed reveals, 1/2" wide, separated by 1/2" ribs, 1/4" deep. Sidewalls have a maximum 1° of taper, and are free of welds or fasteners. A rollformed aluminum flange is hemmed into the bottom providing support for the reflector module. An internal aluminum casting provides for mounting of the electrical module and support for the housing hinge.

Lens Frame Assembly: One-piece cast aluminum lens frame is attached to the housing by a zinc plated cold rolled steel hinge with a stainless steel pin. Closure is by four self-retained stainless steel screws. A zinc plated steel self-locking stop-arm is provided to hold the lens frame or housing in the open position while servicing. A 3/16" thick clear tempered sag-glass lens is fully gasketed by a one-piece extruded and vulcanized silicone gasket. Lens is retained in the lens frame by zinc plated steel clips.

Arm Mounting: Arm is one-piece extruded aluminum with internal bolt guides and fully radiussed top and bottom. Luminaire-to-pole attachment is by internal draw bolts, and includes a pole reinforcing plate with wire strain relief. Arm is circular cut to mate with specified round pole.

Reflector Module: Specular Alzak® optical segments are rigidly mounted within a die-cast aluminum enclosure that attaches to the housing as a one-piece module. Reflectors are field rotatable in 90° increments. All sockets are factory prewired with a quick-disconnect plug for the ballast module. Wire penetrations to the socket are sealed by a silicone gasket to create a totally sealed optical chamber. The optical segments are positioned so that reflected light does not pass through the lamp arc tube. The socket is held in a heat sink die-cast segment and fastened to a multi-position plate set at the factory for "Wide" or "Medium" beam spread. The beam spread can be adjusted in the field with the simple removal of two screws and a turn of the socket brackets. "Narrow" beam reflectors are fixed and non-adjustable. All reflectors are equipped with a mogul base socket rated 4KV. All optical systems are interchangeable within the housing. 400 watt vertical lamps utilize a lamp vibration stabilizer that braces the neck of the lamp with two-prong stainless steel clamp extending from the socket mount.

Electrical Module: All electrical components are UL and CSA recognized, mounted on a single plate and factory prewired with quick-disconnect plugs. Module attaches inside housing using keyhole slots. All ballasts are high power factor with starting temperatures of -40°F. for HPS and -20°F. for PMH lamp modes.

Finish: Super TGIC thermoset polyester powder coat paint, 2.5 mil nominal thickness, applied over a titanated zirconium conversion coating; A.S.T.M. 2500 hour salt spray test endurance rating. Standard colors are Black, Dark Bronze, Light Gray, Stealth Gray™, Platinum Silver, or White. Custom colors are available.

CAUTION: Fixtures must be grounded in accordance with national, state and/or local electrical codes. Failure to do so may result in serious injury.

Listings and Ratings

UL cUL 1598 ¹	CE	IP66 Rated	25C Ambient
(Full) Cut Off ² (Flat Glass Lens Only)			

¹Suitable for wet locations

²Dark Sky Legislation Compliant

KIM LIGHTING RESERVES THE RIGHT TO CHANGE SPECIFICATIONS WITHOUT NOTICE





U.S. Patent: D358,898

Type:

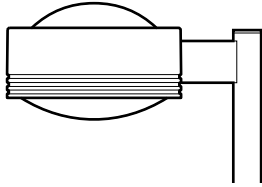
Job:

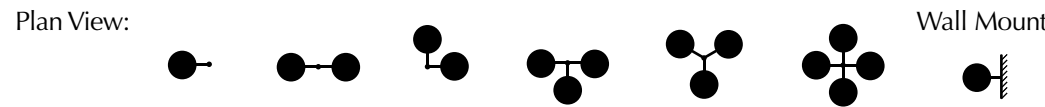

Standard Features

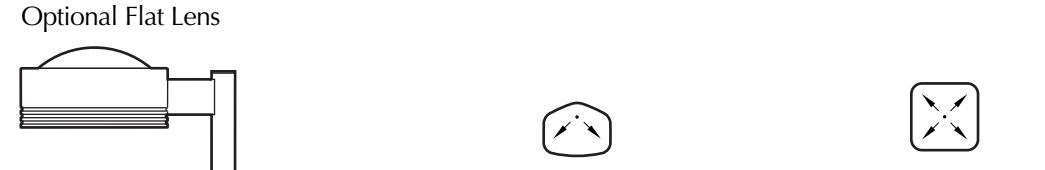
<p>Mounting 3Y configuration is available for round poles or vertical slipfitter mount (VSF) only.</p>	<p>Plan View:</p>  <p>EPA: 1.5 3.0 2.7 4.3 4.3 4.9 —</p> <p>Cat. No.: <input type="checkbox"/> 1A <input type="checkbox"/> 2B <input type="checkbox"/> 2L <input type="checkbox"/> 3T <input type="checkbox"/> 3Y <input type="checkbox"/> 4C <input type="checkbox"/> 1W</p>
<p>Fixture Cat. No. designates VL fixture, light distribution and beam spread.</p> <p>See the Kim Site/Roadway Optical Systems Catalog for detailed information on reflector design and application</p>	<p>Convex Lens</p>  <p>Light Distribution: Beam Spread:</p> <p>Cat. No.: <input type="checkbox"/> VLA25W3 <input type="checkbox"/> VLA25M3 <input type="checkbox"/> VLA25W5 <input type="checkbox"/> VLA25M5</p>
	<p>Optional Flat Lens</p>  <p>Light Distribution: Beam Spread:</p> <p>Cat. No.: <input type="checkbox"/> VLA25N3F^{1,2} <input type="checkbox"/> VLA25N5F^{1,2}</p> <p>NOTE: ¹PMH Flat Lens models must use ED-28 or BT-28 lamps. ²All Flat Lens models are Full Cutoff, Narrow Distribution.</p>

Type:

Job:

Page: 3 of 5

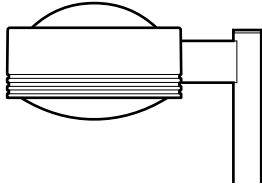

Standard Features

Electrical Module

HPS = High Pressure Sodium

PMH = Pulse Start Metal Halide

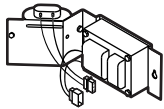

Lamp Watts	Lamp Type	Line Volts
400	HPS	277

Cat. Nos. for Electrical Modules available:

High Pressure Sodium

- | | | |
|------------------------------------|------------------------------------|------------------------------------|
| <input type="checkbox"/> 150HPS120 | <input type="checkbox"/> 250HPS120 | <input type="checkbox"/> 400HPS120 |
| <input type="checkbox"/> 150HPS208 | <input type="checkbox"/> 250HPS208 | <input type="checkbox"/> 400HPS208 |
| <input type="checkbox"/> 150HPS240 | <input type="checkbox"/> 250HPS240 | <input type="checkbox"/> 400HPS240 |
| <input type="checkbox"/> 150HPS277 | <input type="checkbox"/> 250HPS277 | <input type="checkbox"/> 400HPS277 |
| <input type="checkbox"/> 150HPS347 | <input type="checkbox"/> 250HPS347 | <input type="checkbox"/> 400HPS347 |
| <input type="checkbox"/> 150HPS480 | <input type="checkbox"/> 250HPS480 | <input type="checkbox"/> 400HPS480 |

Lamp	E-23½ Clear	ED-18 or ET-18 Clear	ED-18 or ET-18 Clear
Socket	Mogul Base	Mogul Base	Mogul Base
ANSI Ballast	S-55	S-50	S-51

Pulse Start Metal Halide

- | | | |
|------------------------------------|------------------------------------|------------------------------------|
| <input type="checkbox"/> 175PMH120 | <input type="checkbox"/> 250PMH120 | <input type="checkbox"/> 320PMH120 |
| <input type="checkbox"/> 175PMH208 | <input type="checkbox"/> 250PMH208 | <input type="checkbox"/> 320PMH208 |
| <input type="checkbox"/> 175PMH240 | <input type="checkbox"/> 250PMH240 | <input type="checkbox"/> 320PMH240 |
| <input type="checkbox"/> 175PMH277 | <input type="checkbox"/> 250PMH277 | <input type="checkbox"/> 320PMH277 |
| <input type="checkbox"/> 175PMH347 | <input type="checkbox"/> 250PMH347 | <input type="checkbox"/> 320PMH347 |
| <input type="checkbox"/> 175PMH480 | <input type="checkbox"/> 250PMH480 | <input type="checkbox"/> 320PMH480 |

Lamp	ED-28 or BT-28 Clear	ED-28 or BT-28 Clear	BT-28 Clear
Socket	Mogul Base	Mogul Base	Mogul Base
ANSI Ballast	M-137	M-138	M-132, M-154. or M-170

Pulse Start Metal Halide

- | | |
|------------------------------------|------------------------------------|
| <input type="checkbox"/> 350PMH120 | <input type="checkbox"/> 400PMH120 |
| <input type="checkbox"/> 350PMH208 | <input type="checkbox"/> 400PMH208 |
| <input type="checkbox"/> 350PMH240 | <input type="checkbox"/> 400PMH240 |
| <input type="checkbox"/> 350PMH277 | <input type="checkbox"/> 400PMH277 |
| <input type="checkbox"/> 350PMH347 | <input type="checkbox"/> 400PMH347 |
| <input type="checkbox"/> 350PMH480 | <input type="checkbox"/> 400PMH480 |

Lamp	BT-28 Clear	BT-37 ¹ or ED-37 ¹ Clear, or ED-28 ² Clear
Socket	Mogul Base	Mogul Base
ANSI Ballast	M-131, M-171	M-135, M-155, or M-172

¹400PMH Standard convex glass lens models must use ED-37 or BT-37 lamps.

²400PMH Flat Lens models must use ED-28 or BT-28 lamps.

NOTE: Due to the Energy Independence and Security Act (EISA) of 2007, Kim Lighting can no longer supply probe start metal halide ballasts with its luminaires, effective January 1, 2009. Contact Kim Lighting for availability of replacement ballasts for warranty service claims.

(Visit www.aboutlightingcontrols.org or the Library of Congress website for more details).

Finish

Super TGIC powder coat paint over a titanated zirconium conversion coating.

Color: Black Dark Bronze Stealth Gray™ Platinum Silver White Custom Color³
 Cat. No.: **BL** **DB** **SG** **PS** **WH** **CC**

³Custom colors subject to additional charges, minimum quantities and extended lead times. Consult representative. Custom color description: _____

Type:

Job:

Page: 4 of 5

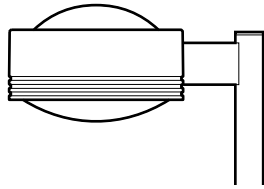

Optional Features

Wall Mounting

Cat. No. **1W**

Select from Mounting on page 2.

Wall Mount: A cast mounting plate of 356 alloy, low-copper (<0.6% Cu) aluminum, is mounted to the wall with bolts (by others). Fixture and arm are mounted to a cast 356 alloy aluminum cover plate before attaching to the wall mounting plate. The fixture-arm-cover plate assembly is hooked to the wall mounting plate, and secured with stainless steel screws provided. After mounting to the wall, field splices are made at the opening in the cover plate, then covered by a cast 356 alloy aluminum plate that blends with the cover plate design. Complete fixture-arm-cover plate assembly can therefore be mounted before field splices are made. Cover plate is finished to match arm and fixture powder coat color.

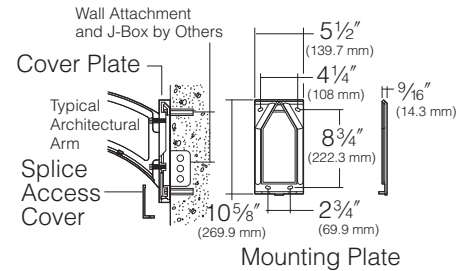

Photocell

Cat. No. (See chart on right)
 No Option

Factory installed photocell inside housing with a fully gasketed sensor on the side wall. For multiple fixture mountings, one fixture is supplied with a photocell to operate the others. Four fixtures (250 watt and less) also require one fixture with a receptacle. (See Cat. Nos. **A-30** through **A-35**.) Four fixtures (400 watt) require two fixtures with receptacles. (See Cat. Nos. **2A-30** through **2A-35**.)

Cat. No.	Line Volts
<input type="checkbox"/> A-30	120V
<input type="checkbox"/> A-31	208V
<input type="checkbox"/> A-32	240V
<input type="checkbox"/> A-33	277V
<input type="checkbox"/> A-35	347V
<input type="checkbox"/> A-34	480V
<input type="checkbox"/> 2A-30	120V
<input type="checkbox"/> 2A-31	208V
<input type="checkbox"/> 2A-32	240V
<input type="checkbox"/> 2A-33	277V
<input type="checkbox"/> 2A-35	347V
<input type="checkbox"/> 2A-34	480V

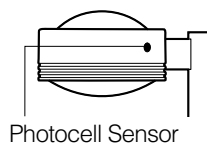

Mounting (see page 2)

* Fixture with photocell receptacle
 s slave unit(s)

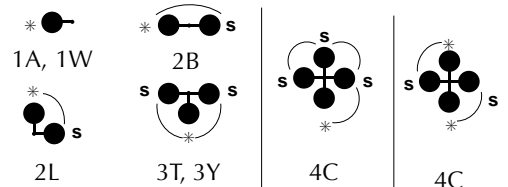

Allowable wattage per fixture:	150-400W	150-250W	400W

Polycarbonate Lens

Cat. No. **L25**
 No Option

Clear UV stabilized convex polycarbonate replaces standard tempered glass lens, gasketed and integral with lens frame. 250 watt maximum. 400 watt HPS is allowable in locations where ambient air temperature will not exceed 85°F during operation.

CAUTION: Use only when vandalism is anticipated to be high. Useful life is limited by UV discoloration from sunlight and metal halide lamps.

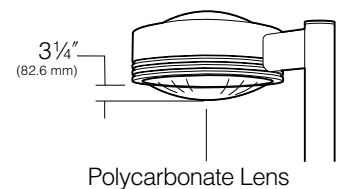

Houseside Shield

Cat. No. (See right)
 No Option

Fixtures with the standard convex glass lens or polycarbonate lens are available with a formed aluminum shield that passes streetside light and blocks houseside light, and a black anodized panel added to the reflector to reduce houseside reflections.

Fixtures with the optional flat glass lens are available with stamped aluminum louvers that pass streetside light and block houseside light, and a blackened panel added to the reflector to reduce houseside reflections.

Note: Recommended for use with clear lamps only.

Cat. No.

HS For fixtures with optional flat glass lens. For use with asymmetric distribution only.

HSC For use with asymmetric distributions only. For fixtures with standard convex glass lens or optional polycarbonate lens.

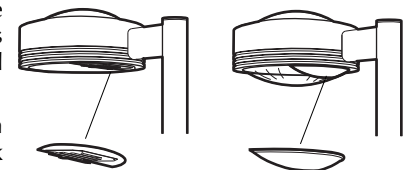

Type:
 Job:

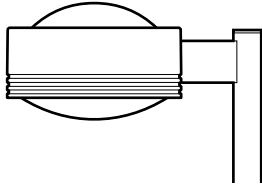

Optional Features

Vertical Slipfitter Mounts

Cat. No. includes Mounting.
 Cat. No. **(See right)**
 No Option

For existing pole installation or for use with poles provided by others.

Allows standard fixture and arm to be mounted to steel poles having a 2" pipe-size steel tenon (2 3/8" O.D. x 4 1/2" min. length). 4" round cast aluminum with flush cap, secured by four 3/8" stainless steel set point allen screws. Pole tenon must be field drilled at one set screw location to insure against fixture rotation. Finished to match fixture.

NOTE: 3Y only available on round slipfitter.

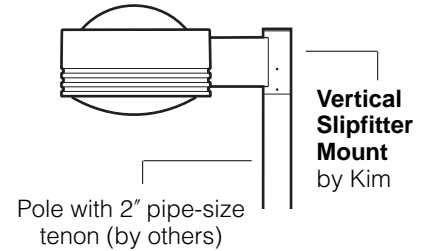

Cat. No.
 VSF-1A
 VSF-2B
 VSF-2L
 VSF-3T
 VSF-3Y
 VSF-4C 4" Round

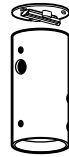

Stainless steel set screws

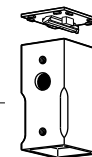

4" Square

Cat. No.
 SVSF-1A
 SVSF-2B
 SVSF-2L
 SVSF-3T
 SVSF-4C

Mounting Configuration
 1A - Single arm mount
 2B - 2 at 180°
 2L - 2 at 90°
 3T - 3 at 90°
 3Y - 3 at 120°
 4C - 4 at 90°

Horizontal Slipfitter Mount

Cat. No. HSF
 No Option

Replaces standard mounting arm with a slipfitter which allows VL Arm Mount model to be mounted to a horizontal pole davit-arm with 2" pipe-size mounting end (2 3/8" O.D.). Cast aluminum clamp-type slipfitter with set screw anti-rotation lock. Bolts to housing from inside the electrical compartment using mounting holes for the standard support arm. Davit-arm must be field drilled at a set screw location to insure against fixture rotation. Finished to match fixture and arm.

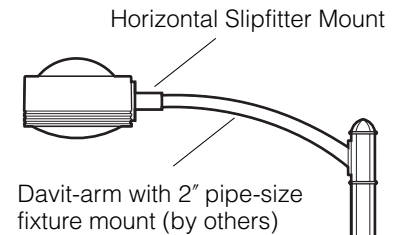

Accent Reveals

Cat. No. **(See right)**
 No Option

Three aluminum bands riveted inside the housing reveals. Available in five standard Kim powder coat finishes. Custom colors available. Super TGIC thermoset polyester powder coat paint, 2.5 mil nominal thickness, applied over a titanated zirconium conversion coating; A.S.T.M. 2500 hour salt spray test endurance rating.

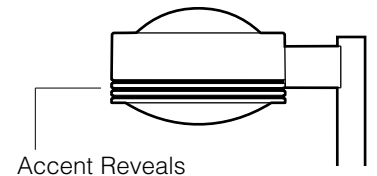

Color: Black Dark Bronze Light Gray Stealth Gray™ Platinum Silver White Custom Colors¹
 Cat. No.: BL-REV DB-REV LG-REV SG-REV PS-REV WH-REV CC-REV

¹Custom colors subject to additional charges, minimum quantities and extended lead times. Consult representative. Custom color description: _____