

**Type:**  
**Job:**  
**Fixture Catalog number:**

---

Fixture Ordered assembled with fixture

**Fixture Options:**

---

Ordered Separately from Fixture  
 See pages 2-3

**Approvals:**

**Date:**  
**Page: 1 of 3**

## Specifications

**Lens Ring:** Die-cast brass, natural finish. Five captive 1/4" blackened stainless steel hex-socket cap screws.

**Lens:** Clear tempered soda lime, 3/16" thick, flush with lens ring, slightly crowned.

**Lens Gasket:** One-piece molded silicone, U-channel wraps completely around lens flange.

**Housing:** Heavy wall die-cast brass.

**Socket:** **LTV766** G4 to GY6.35 socket for bipin lamp, mounted on yoke providing ±15° vertical adjustment and 340° rotation, locking screws, black anodized gimble ring.

**Cable:** 6' #18-2 12 Volt cable with fork connector, sealed entry into body with anti-siphon plug.

**Optical System:** **LTV765** A total of 3 LED emitters configured in a rectangular array comprised together as a module. Available in 3500K and 5100K. Emitters are directly attached to the electronic driver.

**Driver:** **LTV765** Constant current electronic driver. Rated for 5 watts. Available in 12V input. -40°F. starting temperature. All drivers are Underwriters Laboratories recognized.

**Certification:** UL Listed to U.S. and Canadian safety standards for wet locations.

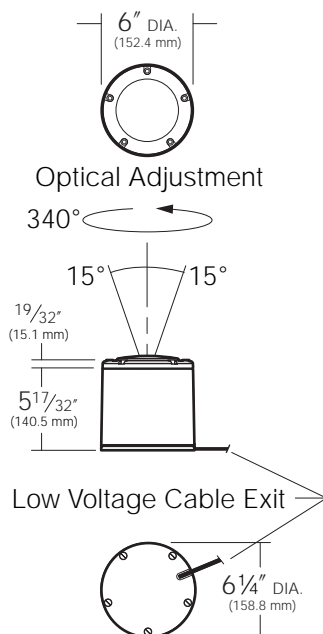

## ORDERING INFORMATION

Fixture	Source	Finish
<input type="checkbox"/> <b>LTV765/3L3K</b>	3.6W, 3 LED's, 3500K <sup>1</sup>	Natural Brass
<input type="checkbox"/> <b>LTV765/3L5K</b>	3.6W, 3 LED's, 5100K <sup>1</sup>	Natural Brass

<sup>1</sup>.3 Max Amps.

Fixture*	Source	Finish
<input type="checkbox"/> <b>LTV766</b>	75W, MR16 Bipin Halogen	Natural Brass

\*Remote Transformer required.

**NOTE:** Surface or In-grade mounting.



KIM LIGHTING RESERVES THE RIGHT TO CHANGE SPECIFICATIONS WITHOUT NOTICE.

Type:



Job:

Page: 2 of 3



## Fixture Options

Ordered Separately from Fixture

<p><b>Lens Accessories</b>          Cat. No. (See right)  <input type="checkbox"/> No Option</p>	<p><b>HL73 - Hex Cell Louver:</b> Constructed of hex cell aluminum louvers providing 45° cutoff, mounted in a circular frame, finished in baked high-heat flat black. Can be used in combination with colored lenses. Inserts behind lens into lens gasket. Cannot be used in combination with <b>SL</b> spread or <b>PL</b> prismatic lenses.</p> <p>Cat. No.  <input type="checkbox"/> <b>HL73</b> Hex Cell Louver</p> <hr/> <p><b>PL73 - Prismatic Lens:</b> Softens lamp distribution and flattens beam spread. Best with flood lamps. Inserts behind lens into lens gasket. Cannot be used in combination with <b>HL73</b> louver.</p> <p>Cat. No.  <input type="checkbox"/> <b>PL73</b> Prismatic Lens</p> <hr/> <p><b>SL73 - Spread Lens:</b> Creates an oval beam pattern, more narrow in one beam axis. Best with spot lamps. Inserts behind lens into lens gasket. Cannot be used in combination with <b>HL73</b> louver.</p> <p>Cat. No.  <input type="checkbox"/> <b>SL73</b> Spread Lens</p>			
--	---	---	---	---

Type:

Job:

Page: 3 of 3



## Fixture Options

Ordered Separately from Fixture

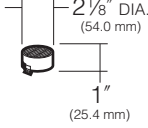
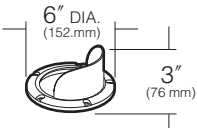
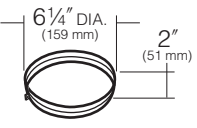
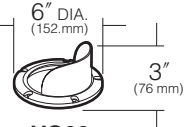
<p><b>Internal Louver</b>          Cat. No.  <input type="checkbox"/> <b>L12</b>  <input type="checkbox"/> <b>No Option</b></p>	<p>Clips onto rim of MR16 lamp and provides additional brightness control.</p>	
<p><b>Half Shield</b>          Cat. No.  <input type="checkbox"/> <b>HS60</b>  <input type="checkbox"/> <b>HS60</b> assembled  <input type="checkbox"/> <b>No Option</b></p>	<p>Lens ring for directional glare control toward the viewer. One-piece cast bronze, replaces standard lens ring. Includes glass lens gasket and mounting screws.          May be ordered separately. To order assembled with fixture, add to fixture <b>Cat. No.</b> - Example: <b>LTV766/HS60</b>.          Replaces standard lens ring.</p>	 <p><b>HS60</b></p>
<p><b>Rock Guard</b>          Cat. No.  <input type="checkbox"/> <b>RG60</b>  <input type="checkbox"/> <b>RG60</b> assembled  <input type="checkbox"/> <b>No Option</b></p>	<p>Lens ring for lens protection in vandal prone areas. One-piece cast bronze, replaces standard lens ring. Includes glass lens gasket and mounting screws.          May be ordered separately. To order assembled with fixture, add to fixture <b>Cat. No.</b> - Example: <b>LTV766/RG60</b>.          Replaces standard lens ring.</p>	 <p><b>RG60</b></p> <p><b>TR60</b></p>
<p><b>Trim Ring</b>          Cat. No.  <input type="checkbox"/> <b>TR60</b>  <input type="checkbox"/> <b>No Option</b></p>	<p>For flush mounting of fixture in concrete pad or paving. Brass ring clamps to housing with stainless steel screw.</p>	 <p><b>HS60</b></p> 