



KIM LIGHTING

LTV750 Series Bronze Housing Accent or Wall Wash

Bronze Lightvault®

revision 8/15/11 • ltv750.pdf

Type:

Job:

Catalog number:

Fixture	Optics	Lamp Mode	Option - order assembled with fixture
_____ / _____	_____ / _____	_____ / _____	_____ / _____
See page 2		See page 3	

Fixture Options:

Ordered separately from fixture
See page 3 - 4

Approvals:

Date:
Page: 1 of 6

Specifications

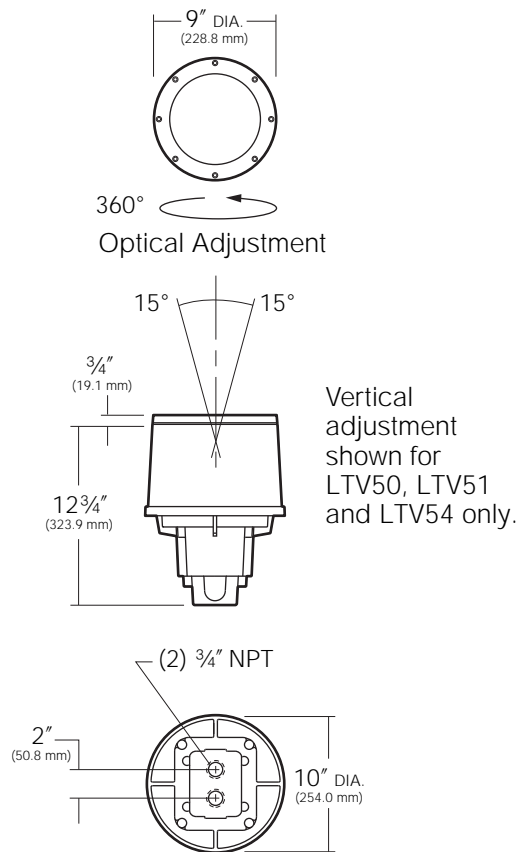

Lens Ring: One-piece cast bronze, natural finish. (Optional standard stainless steel lens ring is also available.) Eight captive 5/16" blackened stainless steel hex-socket cap screws.

Lens: Clear tempered borosilicate glass, 1/4" thick, flush with lens ring, slightly crowned.

Lens Gasket: One-piece molded silicone, U-channel wraps completely around lens flange.

Bronze Housing: Two-piece cast bronze, 3/16" min. wall thickness upper and lower housing continuously soldered together. No top lip to trap dirt and moisture. Separate splice and ballast compartments, individual cast aluminum internal covers with one-piece molded silicone gaskets. Two 3/4" NPT in bottom of 24 cu in. splice area. Modular reverse draft housing design (top smaller than largest bottom diameter).

Optical System: SP and NF - Spot or narrow flood spun aluminum reflector, specular Alzak®, black Duranodic® arc tube glare shield on SP only. (G12 base socket option available.) **PR** - for PAR38 reflector lamps, or PAR36 and AR111 12V lamps in LTV754 only. All sockets 4KV medium base. All optical systems yoke mounted, 360° rotation, ±15° vertical adjustment, locking screws, black anodized gimbal ring. **WW** - one-piece hydroformed reflector, specular Alzak®, 360° rotation and screw locks, wall wash distribution, medium base 4KV socket for HID lamps. (G12 base socket option available.) Mini-can socket for halogen lamps. **PL** - GX24q-3 universal socket is provided for fluorescent.

Electrical Module: High power factor ballast, -20°F starting, factory mounted to gasketed compartment cover, LTV750 and LTV752 only.

Wiring: Anti-siphon barriers on all wiring to and from ballast compartment. All components wire linked for ground, quick-disconnect for removal of optical system.

Drive-over Durability: When installed in concrete (see page 5), fixture will withstand drive-over by vehicles weighing up to 5,500 lb.

See page 6 for safety and warranty information.



Hubbell
Lighting, Inc.

U.S. PATENTS D410,295 AND D411,640

Listings and Ratings

UL cUL 1598 ¹	IP68 Rated	CE	25C Ambient
--------------------------	------------	----	-------------

¹Suitable for wet recessed

KIM LIGHTING RESERVES THE RIGHT TO CHANGE SPECIFICATIONS WITHOUT NOTICE.

Type:



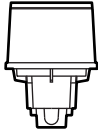



Job:



Standard Features

70
PMH
120
 Lamp Watts Lamp Type Line Volts

PMH = Pulse Start Metal Halide
HPS = High Pressure Sodium
HAL = Halogen
LV = Low Voltage
PL = Compact Fluorescent

Fixture	Optics	Lamp Mode			
Cat. No. <input type="checkbox"/> LTV750 HID Accent	<input type="checkbox"/> SP Spot <input type="checkbox"/> NF Narrow Flood  Yoke mounted reflector and medium base socket for ED-17 HID lamp.	<input type="checkbox"/> PR PAR Lamp  Yoke mounted medium base socket for PAR38 HID reflector lamp.			
		<table border="0"> <tr> <td> Pulse Start Metal Halide <input type="checkbox"/> 50PMH120¹ <input type="checkbox"/> 50PMH208¹ <input type="checkbox"/> 50PMH240¹ <input type="checkbox"/> 50PMH277¹ <input type="checkbox"/> 70PMH120 <input type="checkbox"/> 70PMH208 <input type="checkbox"/> 70PMH240 <input type="checkbox"/> 70PMH277 <input type="checkbox"/> 70PMH347 </td> <td> High Pressure Sodium <input type="checkbox"/> 50HPS120¹ <input type="checkbox"/> 50HPS208¹ <input type="checkbox"/> 50HPS240¹ <input type="checkbox"/> 50HPS277¹ <input type="checkbox"/> 50HPS347¹ <input type="checkbox"/> 70HPS120¹ <input type="checkbox"/> 70HPS208¹ <input type="checkbox"/> 70HPS240¹ <input type="checkbox"/> 70HPS277¹ <input type="checkbox"/> 70HPS347¹ </td> <td> Compact Fluorescent <input type="checkbox"/> 32PL120¹ <input type="checkbox"/> 32PL208¹ <input type="checkbox"/> 32PL240¹ <input type="checkbox"/> 32PL277¹ </td> </tr> </table> <p>¹Not available for PR optics.</p>	Pulse Start Metal Halide <input type="checkbox"/> 50PMH120 ¹ <input type="checkbox"/> 50PMH208 ¹ <input type="checkbox"/> 50PMH240 ¹ <input type="checkbox"/> 50PMH277 ¹ <input type="checkbox"/> 70PMH120 <input type="checkbox"/> 70PMH208 <input type="checkbox"/> 70PMH240 <input type="checkbox"/> 70PMH277 <input type="checkbox"/> 70PMH347	High Pressure Sodium <input type="checkbox"/> 50HPS120 ¹ <input type="checkbox"/> 50HPS208 ¹ <input type="checkbox"/> 50HPS240 ¹ <input type="checkbox"/> 50HPS277 ¹ <input type="checkbox"/> 50HPS347 ¹ <input type="checkbox"/> 70HPS120 ¹ <input type="checkbox"/> 70HPS208 ¹ <input type="checkbox"/> 70HPS240 ¹ <input type="checkbox"/> 70HPS277 ¹ <input type="checkbox"/> 70HPS347 ¹	Compact Fluorescent <input type="checkbox"/> 32PL120 ¹ <input type="checkbox"/> 32PL208 ¹ <input type="checkbox"/> 32PL240 ¹ <input type="checkbox"/> 32PL277 ¹
Pulse Start Metal Halide <input type="checkbox"/> 50PMH120 ¹ <input type="checkbox"/> 50PMH208 ¹ <input type="checkbox"/> 50PMH240 ¹ <input type="checkbox"/> 50PMH277 ¹ <input type="checkbox"/> 70PMH120 <input type="checkbox"/> 70PMH208 <input type="checkbox"/> 70PMH240 <input type="checkbox"/> 70PMH277 <input type="checkbox"/> 70PMH347	High Pressure Sodium <input type="checkbox"/> 50HPS120 ¹ <input type="checkbox"/> 50HPS208 ¹ <input type="checkbox"/> 50HPS240 ¹ <input type="checkbox"/> 50HPS277 ¹ <input type="checkbox"/> 50HPS347 ¹ <input type="checkbox"/> 70HPS120 ¹ <input type="checkbox"/> 70HPS208 ¹ <input type="checkbox"/> 70HPS240 ¹ <input type="checkbox"/> 70HPS277 ¹ <input type="checkbox"/> 70HPS347 ¹	Compact Fluorescent <input type="checkbox"/> 32PL120 ¹ <input type="checkbox"/> 32PL208 ¹ <input type="checkbox"/> 32PL240 ¹ <input type="checkbox"/> 32PL277 ¹			
Cat. No. <input type="checkbox"/> LTV751 Halogen Accent	<input type="checkbox"/> PR PAR Lamp  Yoke mounted medium base socket for PAR38 halogen reflector lamp.	<input type="checkbox"/> 120HAL120 120W maximum, lower wattage lamps may be used.			
Cat. No. <input type="checkbox"/> LTV752 HID Wall Wash	<input type="checkbox"/> WW Wall Wash  Hydroformed reflector and medium base socket for ED-17 HID lamp.	<table border="0"> <tr> <td> Pulse Start Metal Halide <input type="checkbox"/> 50PMH120 <input type="checkbox"/> 50PMH208 <input type="checkbox"/> 50PMH240 <input type="checkbox"/> 50PMH277 <input type="checkbox"/> 70PMH120 <input type="checkbox"/> 70PMH208 <input type="checkbox"/> 70PMH240 <input type="checkbox"/> 70PMH277 <input type="checkbox"/> 70PMH347 </td> <td> High Pressure Sodium <input type="checkbox"/> 50HPS120 <input type="checkbox"/> 50HPS208 <input type="checkbox"/> 50HPS240 <input type="checkbox"/> 50HPS277 <input type="checkbox"/> 50HPS347 <input type="checkbox"/> 70HPS120 <input type="checkbox"/> 70HPS208 <input type="checkbox"/> 70HPS240 <input type="checkbox"/> 70HPS277 <input type="checkbox"/> 70HPS347 </td> <td> Compact Fluorescent <input type="checkbox"/> 26PL120 <input type="checkbox"/> 26PL208 <input type="checkbox"/> 26PL240 <input type="checkbox"/> 26PL277 </td> </tr> </table>	Pulse Start Metal Halide <input type="checkbox"/> 50PMH120 <input type="checkbox"/> 50PMH208 <input type="checkbox"/> 50PMH240 <input type="checkbox"/> 50PMH277 <input type="checkbox"/> 70PMH120 <input type="checkbox"/> 70PMH208 <input type="checkbox"/> 70PMH240 <input type="checkbox"/> 70PMH277 <input type="checkbox"/> 70PMH347	High Pressure Sodium <input type="checkbox"/> 50HPS120 <input type="checkbox"/> 50HPS208 <input type="checkbox"/> 50HPS240 <input type="checkbox"/> 50HPS277 <input type="checkbox"/> 50HPS347 <input type="checkbox"/> 70HPS120 <input type="checkbox"/> 70HPS208 <input type="checkbox"/> 70HPS240 <input type="checkbox"/> 70HPS277 <input type="checkbox"/> 70HPS347	Compact Fluorescent <input type="checkbox"/> 26PL120 <input type="checkbox"/> 26PL208 <input type="checkbox"/> 26PL240 <input type="checkbox"/> 26PL277
Pulse Start Metal Halide <input type="checkbox"/> 50PMH120 <input type="checkbox"/> 50PMH208 <input type="checkbox"/> 50PMH240 <input type="checkbox"/> 50PMH277 <input type="checkbox"/> 70PMH120 <input type="checkbox"/> 70PMH208 <input type="checkbox"/> 70PMH240 <input type="checkbox"/> 70PMH277 <input type="checkbox"/> 70PMH347	High Pressure Sodium <input type="checkbox"/> 50HPS120 <input type="checkbox"/> 50HPS208 <input type="checkbox"/> 50HPS240 <input type="checkbox"/> 50HPS277 <input type="checkbox"/> 50HPS347 <input type="checkbox"/> 70HPS120 <input type="checkbox"/> 70HPS208 <input type="checkbox"/> 70HPS240 <input type="checkbox"/> 70HPS277 <input type="checkbox"/> 70HPS347	Compact Fluorescent <input type="checkbox"/> 26PL120 <input type="checkbox"/> 26PL208 <input type="checkbox"/> 26PL240 <input type="checkbox"/> 26PL277			
Cat. No. <input type="checkbox"/> LTV753 Halogen Wall Wash	<input type="checkbox"/> WW Wall Wash  Hydroformed reflector and socket for T-4 Halogen mini-can lamp.	<input type="checkbox"/> 150HAL120 150W maximum, lower wattage lamps may be used.			
Cat. No. <input type="checkbox"/> LTV754 Low Voltage Accent	<input type="checkbox"/> PR PAR Lamp  Yoke and slip-on wire tabs for PAR36 or AR111 12V lamp.	<input type="checkbox"/> 100LV120 <input type="checkbox"/> 100LV277 12V lamps with 120V or 277V input to fixture. 100W maximum, lower wattage lamps may be used.			



Type:

Job:

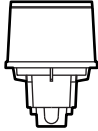

Optional Features

<p>G12 Base Socket Cat. No. <input type="checkbox"/> G12 socket <input type="checkbox"/> No Option</p>	<p>Socket is available for 70W Pulse Start Metal Halide T-6 Bipin lamps.</p>	
<p>Brushed Stainless Steel Lens Ring Cat. No. <input type="checkbox"/> SS50 <input type="checkbox"/> SS50 (Assembled) <input type="checkbox"/> No Option</p>	<p>One-piece standard brushed stainless steel replaces standard lens ring. Includes glass lens gasket and mounting screws. May be ordered separately. To order assembled with fixture, add to fixture Cat. No. - Example: LTV750/xx/xxxxxxxx/SS50</p>	
<p>Half Shield Cat. No. <input type="checkbox"/> HS50 <input type="checkbox"/> No Option</p>	<p>Half shield lens ring for directional glare control toward the viewer. One-piece cast bronze, replaces standard lens ring. Includes glass lens gasket and mounting screws.</p>	
<p>Rock Guard Cat. No. <input type="checkbox"/> RG50 <input type="checkbox"/> No Option</p>	<p>Rock guard lens ring for lens protection in vandal prone areas. One-piece cast bronze, replaces standard lens ring. Includes glass lens gasket and mounting screws. CAUTION: On LTV752, rock guard will cast severe shadows on the lighted surface with clear lamps. If rock guard is required, use coated lamps and estimate a 50% reduction in longitudinal light throw and intensity. Rock guard not recommended for LTV753 halogen wall wash fixtures.</p>	
<p>Trim Ring Cat. No. <input type="checkbox"/> TR50 <input type="checkbox"/> No Option</p>	<p>Trim ring for flush mounting of fixture in concrete pad or paving. Brass ring clamps to housing with stainless steel screw.</p>	
<p>Grout Mask Cat. No. <input type="checkbox"/> GM50 TR50 Trim Ring Included <input type="checkbox"/> No Option</p>	<p>Grout mask for fixture support during concrete pour. Galvanized steel ring and rebar supports fixture when tied into paving rebar. 2" grout space provided for finishing up to fixture (see page 5).</p>	



Type:

Job:

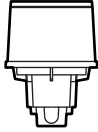

Optional Features

Lens Accessories

Cat. No. (See right)

No Option

HL - Hex Cell Louver: Constructed of hex cell aluminum louvers with a cell dimension of 1/4" W x 1/4" D, producing a 45° cutoff angle, mounted in a circular frame, finished in baked high-heat flat black. May be used in combination with colored lenses. Inserts behind lens into lens gasket.

Not for use in combination with **SL** spread or **PL** prismatic lenses.

Not for use with **WW** optics.

Cat. No.

HL50 Hex Cell Louver



PL - Prismatic Lens: Softens lamp distribution. Best with flood lamps. Inserts behind lens into lens gasket.

Not for use in combination with **HL50** louver.

Not for use with **WW** optics.

Cat. No.

PL50 Prismatic Lens



SL - Spread Lens: Creates an oval beam pattern. Best with spot lamps. Inserts behind lens into lens gasket.

Not for use in combination with **HL50** louver.

Not for use with **WW** optics.

Cat. No.

SL50 Spread Lens





Type:

Job:

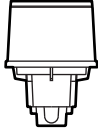

Installation Recommendations

Create a Buffer Zone

When fixtures are located in areas planted in ground cover or shrubbery, construct a buffer zone to prevent lens overgrowth and to create an edge for trimming. Elevate the fixtures for drainage and backfill with decorative rock. As the ground cover grows, the fixtures will look flush even though they are 2" to 4" above grade.

Advantages

- Prevents lens overgrowth.
- Provides a defined edge for trimming.
- Provides drainage away from the lens to maintain light output.
- Visually looks like a flush installation.

Buffer Zone

Redwood or other material for edging.

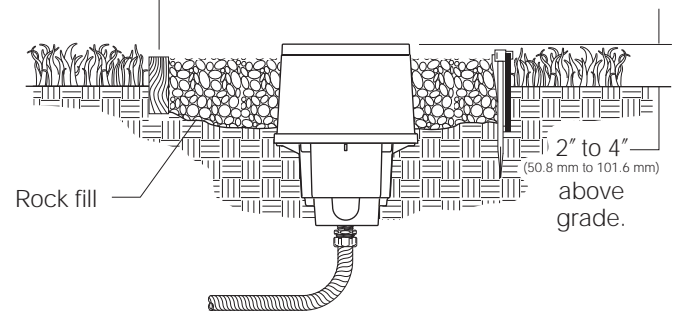

Install in Concrete

For installations in ground cover, shrubbery or lawn areas, encase the fixture in concrete. This creates a buffer zone with the additional advantage of greater fixture stability. Elevate the fixture 2" to 4" above grade, and slope the concrete away from the lens ring for drainage.

Advantages

- Cleaner, more stable installation, less susceptible to traffic and maintenance activity.
- Prevents lens overgrowth.
- Provides a defined edge for trimming.
- Provides drainage away from the lens to maintain light output.
- Visually looks like a flush installation.

Concrete Installation

Concrete must have reinforcing rods to prevent cracking from fixture heat expansion.

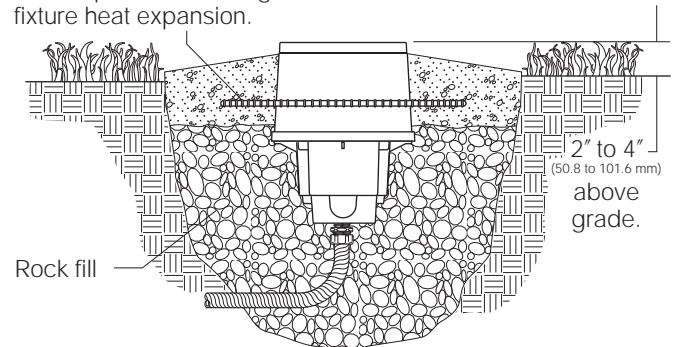

NOTE: Always use adequate rebar surrounding the fixture to prevent cracking of the concrete due to heat expansion.

In Paved Areas

When in-grade luminaires are installed in paving, it is usually required that the lens frame be flush with finished grade. To make this installation easier, Kim offers an optional grout mask (page 3) to support the fixture at the proper height during the concrete pour. The grout mask is normally tied into the paving rebar for support.

Advantages

- Supports fixture at proper height during concrete pour.
- Provides 2" grout space for finishing.
- Easily adapts to any paving material; concrete, brick, stone, etc.
- Provides maximum drive-over durability.

Paved Area Installation

Optional grout mask supports fixture during concrete pour.

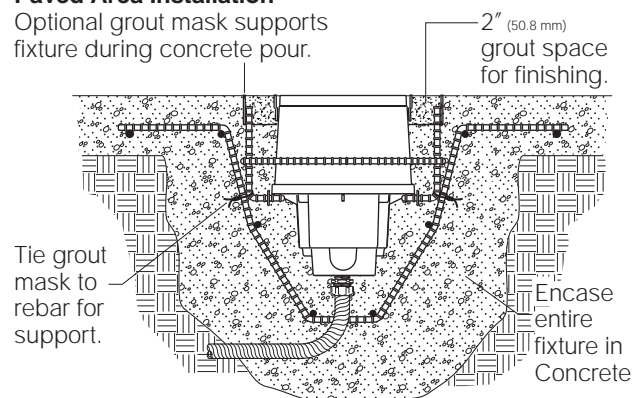

NOTE: See safety and warranty information on page 6.



Type:

Job:

Page: 6 of 6

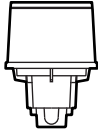

Safety and Warranty Information

Safety and Maintenance Warning

1. Fixtures must be grounded in accordance with national, state, and/or local codes. Failure to do so may result in serious personal injury.
2. Extreme caution should be taken when fixtures are used in paved areas. High temperature lenses can burn feet, hands or objects inadvertently placed on top of fixtures. If fixtures must be used in paved areas, locate them away from normal pedestrian traffic, and use the lowest wattage lamp possible.
3. It is recommended that all conduit entries be sealed with RTV silicone to maintain a clean, dry splice compartment.
4. To maintain light efficiency and prevent fixture overheating, lenses must be kept clean and free of dirt, dust, leaves, and trash.
5. Lightvault fixtures are not approved for any submersible installations including fountains, ponds, reflecting ponds or swimming pools.

25 Year Limited Warranty

When installed according to Kim Installation Instructions and accepted trade practices, the solid bronze on LTV Series Kim products is warranted for 25 years, from date of sale, against manufacturing defects and failure due to corrosion. All other fixture components (excluding lamps) are warranted to be free of defects in material and workmanship for 1 year from date of sale. During the warranty periods, with proof of purchase, Kim will repair or replace with the same or similar product, at Kim's option, without charge. Labor costs are the owner's responsibility and are excluded from this warranty. This warranty is void if the product is modified, tampered with, misapplied, poorly installed, improperly maintained or subjected to abnormal conditions.

Repair or replacement as provided under this warranty is the exclusive remedy of the purchaser. This warranty is in lieu of all other warranties, expressed or implied, including any implied warranty of fitness for the particular application. Kim Lighting shall not be liable to the purchaser for indirect or consequential damages.