



KIM LIGHTING

LTV730 Series Bronze Housing Accent or Wall Wash

Bronze Lightvault®

revision 8/15/11 • ltv730.pdf

Type:
Job:
Catalog number:

Approvals:

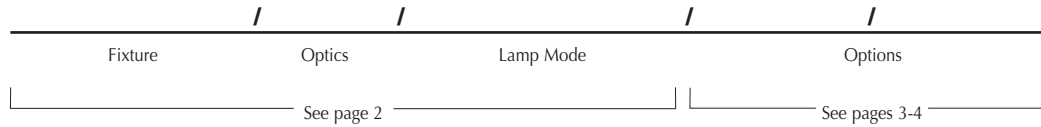

Date:
Page: 1 of 6

Specifications

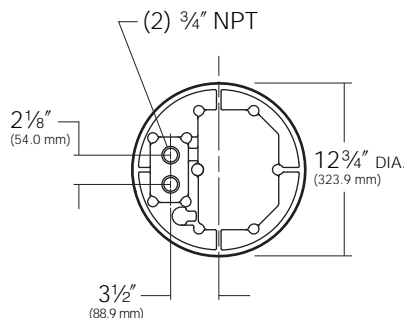
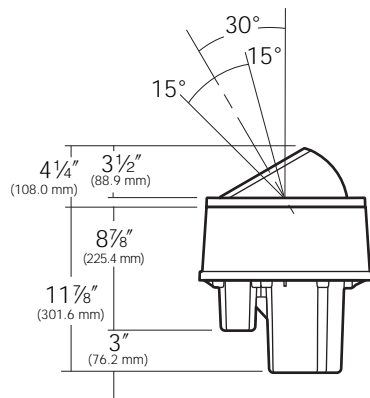
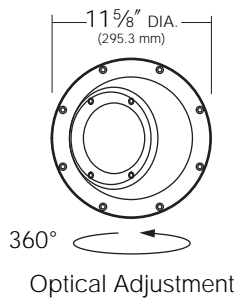

Eyeball Retaining Ring: Cast bronze, natural finish. Eight captive 5/16" blackened stainless steel hex-socket cap screws.

Eyeball: Cast bronze, natural finish. 360° rotation within retaining ring. Holds optical assemblies at 30° from vertical.

Lens Ring: Cast bronze, natural finish, beveled for water runoff. Four captive 1/4" blackened stainless steel hex-socket cap screws.

Lens: Clear tempered flat glass, 3/16" thick.

Lens Gasket: One-piece molded silicone, U-channel wraps completely around lens edge.

Bronze Housing: Two-piece cast bronze, 3/16" min. wall thickness upper and lower housing continuously soldered together. No top lip to trap dirt and moisture. Separate splice and ballast compartments, individual cast aluminum internal covers with one-piece molded silicone gaskets. Two 3/4" NPT in bottom of 33 cu in. splice area. Modular reverse draft housing design (top smaller than largest bottom diameter).

Optical System: SP and NF - Spot or narrow flood spun aluminum reflectors, specular Alzak®, black Duranodic® arc tube glare shield on SP only. (G12 base socket option available.) **PR** - for PAR38 reflector lamps. All optical systems yoke mounted, 360° rotation, ±15° vertical adjustment (15° to 45° from 0° vertical), locking screws, black hi-temp finish gimbal ring. **WW** - one-piece hydroformed reflector, specular Alzak®, 360° rotation and screw locks, wall wash distribution. All medium base sockets rated 4KV; mini-can socket for halogen lamps. (G12 base socket option available.) **PL** - GX24q-3 universal socket is provided for fluorescent.

Electrical Module: High power factor ballast, -20°F starting, factory mounted to gasketed compartment cover, LTV730 and LTV732 only.

Wiring: Anti-siphon barriers on all wiring to and from ballast compartment. All components wire linked for ground, quick-disconnect for removal of optical system.

See page 6 for Safety and Warranty Information.



Hubbell Lighting, Inc.

U.S. PATENTS D410,295 AND D411,640

Listings and Ratings

UL cUL 1598*	IP68 Rated	CE	25C Ambient
--------------	------------	----	-------------

*Suitable for wet recessed

KIM LIGHTING RESERVES THE RIGHT TO CHANGE SPECIFICATIONS WITHOUT NOTICE.





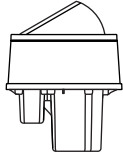

Type:
Job:



Standard Features

150 PMH 120
Lamp Watts Lamp Type Line Volts

PMH = Pulse Start Metal Halide
HPS = High Pressure Sodium
HAL = Halogen
PL = Compact Fluorescent

Fixture	Optics	Lamp Mode
Cat. No. <input type="checkbox"/> LTV730 H.I.D. Accent	<input type="checkbox"/> SP Spot <input type="checkbox"/> NF Narrow Flood  Yoke mounted reflector and medium base socket for ED-17 HID lamp.	<input type="checkbox"/> PR PAR Lamp  Yoke mounted medium base socket for PAR38 HID reflector lamp.
	<input type="checkbox"/> HPS and PL not available for PR optics.	Pulse Start Metal Halide <input type="checkbox"/> 70PMH120 <input type="checkbox"/> 70PMH208 <input type="checkbox"/> 70PMH240 <input type="checkbox"/> 70PMH277 <input type="checkbox"/> 70PMH347 <input type="checkbox"/> 100PMH120 <input type="checkbox"/> 100PMH208 <input type="checkbox"/> 100PMH240 <input type="checkbox"/> 100PMH277 <input type="checkbox"/> 100PMH347 <input type="checkbox"/> 150PMH120 <input type="checkbox"/> 150PMH208 <input type="checkbox"/> 150PMH240 <input type="checkbox"/> 150PMH277 <input type="checkbox"/> 150PMH347
Cat. No. <input type="checkbox"/> LTV731 Halogen Accent	<input type="checkbox"/> PR PAR Lamp  Yoke mounted medium base socket for PAR38 halogen reflector lamp.	<input type="checkbox"/> 250HAL120 250W maximum, lower wattage lamps may be used.
Cat. No. <input type="checkbox"/> LTV732 H.I.D. Wall Wash	<input type="checkbox"/> WW Wall Wash  Hydroformed reflector and medium base socket for ED-17 HID lamp.	Pulse Start Metal Halide <input type="checkbox"/> 70PMH120 <input type="checkbox"/> 70PMH208 <input type="checkbox"/> 70PMH240 <input type="checkbox"/> 70PMH277 <input type="checkbox"/> 70PMH347 <input type="checkbox"/> 100PMH120 <input type="checkbox"/> 100PMH208 <input type="checkbox"/> 100PMH240 <input type="checkbox"/> 100PMH277 <input type="checkbox"/> 100PMH347 <input type="checkbox"/> 150PMH120 <input type="checkbox"/> 150PMH208 <input type="checkbox"/> 150PMH240 <input type="checkbox"/> 150PMH277 <input type="checkbox"/> 150PMH347
Cat. No. <input type="checkbox"/> LTV733 Halogen Wall Wash	<input type="checkbox"/> WW Wall Wash  Hydroformed reflector and socket for T-4 Halogen mini-can lamp.	<input type="checkbox"/> 250HAL120 250W maximum, lower wattage lamps may be used.



Type:

Job:

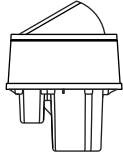

Optional Features

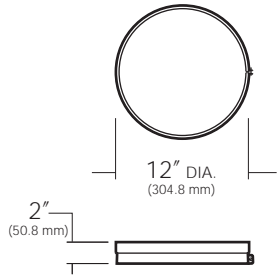
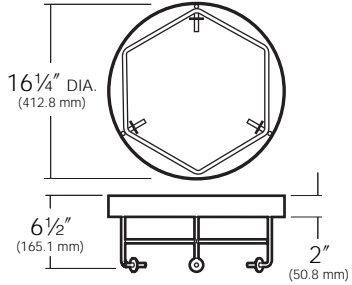
<p>G12 Base Socket Cat. No. <input type="checkbox"/> G12 socket <input type="checkbox"/> No Option</p>	<p>Socket is available for 70W and 150W Pulse Start Metal Halide T-6 Bipin lamps.</p>
<p>Trim Ring Cat. No. <input type="checkbox"/> TR10 <input type="checkbox"/> No Option</p>	<p>Trim ring for flush mounting of fixture in concrete pad or paving. Brass ring clamps to housing with stainless steel screw.</p> 
<p>Grout Mask Cat. No. <input type="checkbox"/> GM30 <input type="checkbox"/> TR10 Trim Ring Included <input type="checkbox"/> No Option</p>	<p>Grout mask for fixture support during concrete pour. Galvanized steel ring and rebar supports fixture when tied into paving rebar. 2" grout space provided for finishing up to fixture (see page 5).</p> 



Type:

Job:

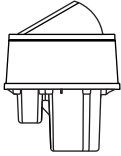

Optional Features

Lens Accessories

Cat. No. (See right)

No Option

HL - Hex Cell Louver: Constructed of hex cell aluminum louvers with a cell dimension of 1/4" W x 1/4" D, producing a 45° cutoff angle, mounted in a circular frame, finished in baked high-heat flat black. May be used in combination with colored lenses. Inserts behind lens into lens gasket.

Not for use in combination with **SL** spread or **PL** prismatic lenses.

Cat. No.

HL30 Hex Cell Louver



PL - Prismatic Lens: Softens lamp distribution. Best with flood lamps. Inserts behind lens into lens gasket.

Not for use in combination with **HL30** louver.

Cat. No.

PL30 Prismatic Lens



SL - Spread Lens: Creates an oval beam pattern. Best with spot lamps. Inserts behind lens into lens gasket.

Not for use in combination with **HL30** louver.

Cat. No.

SL30 Spread Lens





Type:

Job:

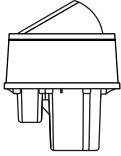

Installation Recommendations

Create a Buffer Zone

When fixtures are located in areas planted in ground cover or shrubbery, construct a buffer zone to prevent lens overgrowth and to create an edge for trimming. Elevate the fixtures for drainage and backfill with decorative rock. As the ground cover grows, the fixtures will look flush even though they are 2" to 4" above grade.

Advantages

- Prevents lens overgrowth.
- Provides a defined edge for trimming.
- Provides drainage away from the lens to maintain light output.
- Visually looks like a flush installation.

Buffer Zone

Redwood or other material for edging.

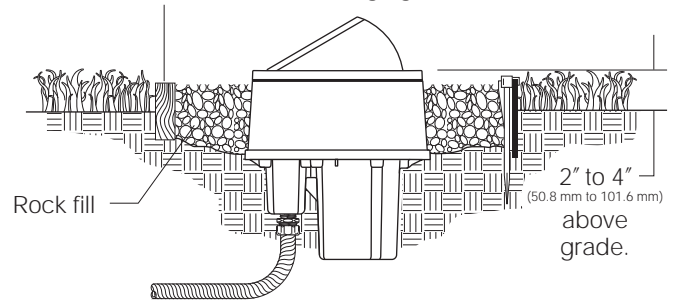

Install in Concrete

For installations in ground cover, shrubbery or lawn areas, encase the fixture in concrete. This creates a buffer zone as described above with the additional advantage of greater fixture stability. Elevate the fixture 2" to 4" above grade, and slope the concrete away from the lens for drainage.

Advantages

- Cleaner, more stable installation, less susceptible to traffic and maintenance activity.
- Prevents lens overgrowth.
- Provides a defined edge for trimming.
- Provides drainage away from the lens to maintain light output.
- Visually looks like a flush installation.

Concrete Installation

Concrete must have reinforcing rods to prevent cracking from fixture heat expansion.

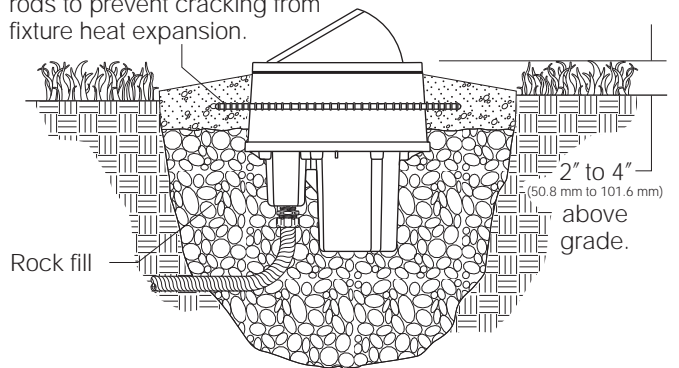

NOTE: Always use adequate rebar surrounding the fixture to prevent cracking of the concrete due to heat expansion.

In Paved Areas

When in-grade luminaires are installed in paving, it is usually required that the lens frame be flush with finished grade. To make this installation easier, Kim offers an optional grout mask (page 3) to support the fixture at the proper height during the concrete pour. The grout mask is normally tied into the paving rebar for support.

Advantages

- Supports fixture at proper height during concrete pour.
- Provides 2" grout space for finishing.
- Easily adapts to any paving material; concrete, brick, stone, etc.
- Provides maximum drive-over durability.

Paved Area Installation

Optional grout mask supports fixture during concrete pour.

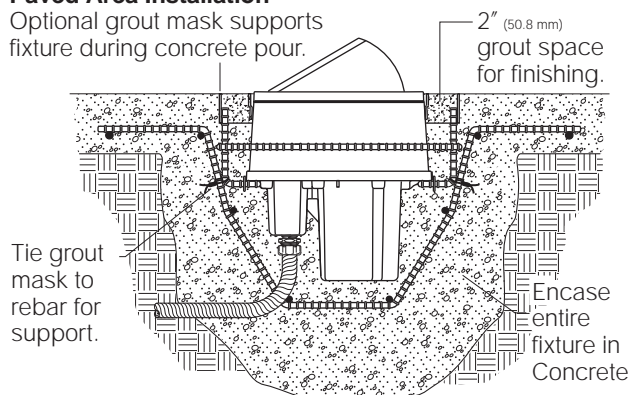

NOTE: See safety and warranty information on page 6.



Type:

Job:

Page: 6 of 6

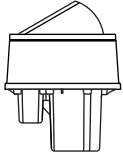

Safety and Warranty Information

Safety and Maintenance Warning

1. Fixtures must be grounded in accordance with national, state, and/or local codes. Failure to do so may result in serious personal injury.
2. Extreme caution should be taken when fixtures are used in paved areas. High temperature lenses can burn feet, hands or objects inadvertently placed on top of fixtures. If fixtures must be used in paved areas, locate them away from normal pedestrian traffic, and use the lowest wattage lamp possible.
3. It is recommended that all conduit entries be sealed with RTV silicone to maintain a clean, dry splice compartment.
4. To maintain light efficiency and prevent fixture overheating, lenses must be kept clean and free of dirt, dust, leaves, and trash.
5. Lightvault fixtures are not approved for any submersible installations including fountains, ponds, reflecting ponds or swimming pools.

25 Year Limited Warranty

When installed according to Kim Installation Instructions and accepted trade practices, the solid bronze on LTV Series Kim products is warranted for 25 years, from date of sale, against manufacturing defects and failure due to corrosion. All other fixture components (excluding lamps) are warranted to be free of defects in material and workmanship for 1 year from date of sale. During the warranty periods, with proof of purchase, Kim will repair or replace with the same or similar product, at Kim's option, without charge. Labor costs are the owner's responsibility and are excluded from this warranty. This warranty is void if the product is modified, tampered with, misapplied, poorly installed, improperly maintained or subjected to abnormal conditions.

Repair or replacement as provided under this warranty is the exclusive remedy of the purchaser. This warranty is in lieu of all other warranties, expressed or implied, including any implied warranty of fitness for the particular application. Kim Lighting shall not be liable to the purchaser for indirect or consequential damages.