

Type:
Job:
Fixture Catalog number:

LTV72 / / /
Fixture Optics Source Temperature Voltage

Fixture Options:

Ordered separately from fixture
See page 2

Approvals:

Date:
Page: 1 of 2

Specifications

Eyeball Ring: Cast bronze, natural finish, beveled for water runoff. Four captive 1/4" stainless steel hex-socket cap screws.

Lens: Clear tempered flat glass, 1/8" thick.

Eyeball: Cast bronze, natural finish. 360° rotation at 45° integrals. Eight captive 5/16" stainless steel screws.

Lens Gasket: One-piece molded silicone, U-channel wraps completely around lens flange.

Composite Housing: High temperature, compression molded fiberglass impregnated, 3/16" min. wall composite. Charcoal gray. No top lip to trap dirt and moisture. Molded-in solid brass knurled inserts to receive socket base screws. Separate driver and splice compartments, individual cast aluminum internal covers, with silicone gaskets. Two 3/4" NPT in bottom, 24 cu. in. splice area. Body and driver modules epoxy bonded.

Electronic Module: All electrical components are UL and CSA recognized, mounted on a single plate and factory prewired with quick-disconnect plugs. Driver is rated for -40°F starting.

Optical Module: Precision, replaceable MicroEmitters (WW) or optical prisms (SP, NF) are positioned to achieve directional control toward desired task. Available in 3500K and 5100K color temperatures.

Wiring: Anti-siphon barrier on wiring to and from splice compartment. All components wire linked for ground, quick-disconnect for removal of optical system.

Distribution: Specify "SP" for spot distributon; specify "NF" for narrow flood distribution; specify "WW" for wall wash distribution.

Limited Warranty: When installed according to Kim Installation Instructions and accepted trade practices, the solid bronze trim rings on LTV Series Kim products are warranted for 25-years, and the composite housings are warranted for 7-years, from date of sale, against manufacturing defects and failure due to corrosion. All other fixture options are warranted to be free of defects in material and workmanship for one year from date of sale.

Kim Lighting's LED engine and driver carry a 3-year warranty.¹

¹This warranty is void if the product is incorrectly sealed at installation, modified, tampered with, misapplied, poorly installed or subject to abnormal conditions.



ORDERING INFORMATION

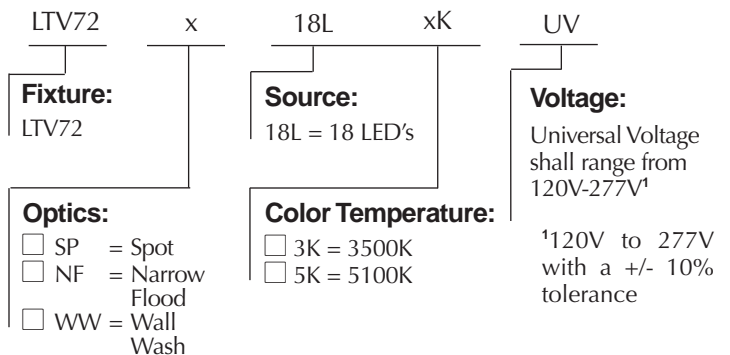

OPTICAL SYSTEMS

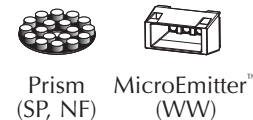

DISTRIBUTIONS

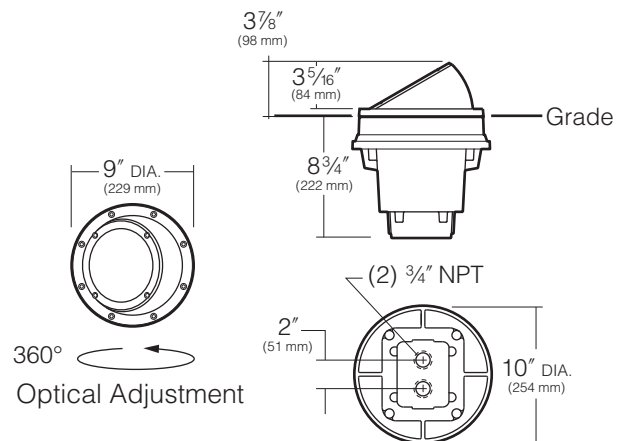
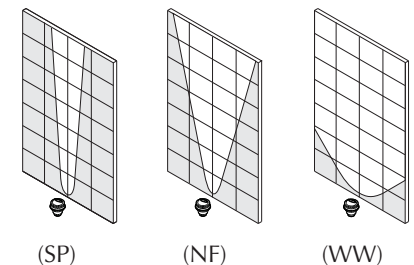

Listings and Ratings

UL cUL 1598 ²	IP68 Rated	25C Ambient
--------------------------	------------	-------------

²Suitable for wet locations

KIM LIGHTING RESERVES THE RIGHT TO CHANGE SPECIFICATIONS WITHOUT NOTICE.



Type:

Job:

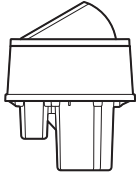
Page: 2 of 2

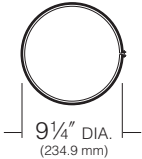

Optional Features

<p>Trim Ring Cat. No. <input type="checkbox"/> TR50 <input type="checkbox"/> No Option</p>	<p>For flush mounting of fixture in concrete pad or paving. Brass ring clamps to housing with stainless steel screw.</p>	 <p>9 1/4" DIA. (234.9 mm)</p>
<p>Lens Accessories Cat. No. (See right) <input type="checkbox"/> No Option</p>	<p>HL - Hex Cell Louver: Constructed of hex cell aluminum louvers with a cell dimension of 1/4" W x 1/4" D, producing a 45° cutoff angle, mounted in a circular frame, finished in baked high-heat flat black. May be used in combination with colored lenses. Inserts behind lens into lens gasket. Not for use in combination with SL spread or PL prismatic lenses. Cat. No. <input type="checkbox"/> HL30 Hex Cell Louver</p>	
<p>PL - Prismatic Lens: Softens lamp distribution. Best with flood lamps. Inserts behind lens into lens gasket. Not for use in combination with HL50 louver. Cat. No. <input type="checkbox"/> PL30 Prismatic Lens</p>		
<p>SL - Spread Lens: Creates an oval beam pattern. Best with spot lamps. Inserts behind lens into lens gasket. Not for use in combination with HL30 louver. Cat. No. <input type="checkbox"/> SL30 Spread Lens</p>	