



KIM LIGHTING

CC/CCS 25" Post Top Mounted

Curvilinear Cutoff

revision 10/1/08 • cc25p.pdf

Type:

Job:

Catalog number:

/	/	/	/
Mtg.	Fixture	Electrical Module	Finish Options
See page 2		See page 3	

Select pole from Kim Arms and Poles Selection Guide. If pole is provided by others indicate O.D. for arm fitting.

Approvals:

Date:

Page: 1 of 5

Specifications

25" Diameter
150 to 400 Watt

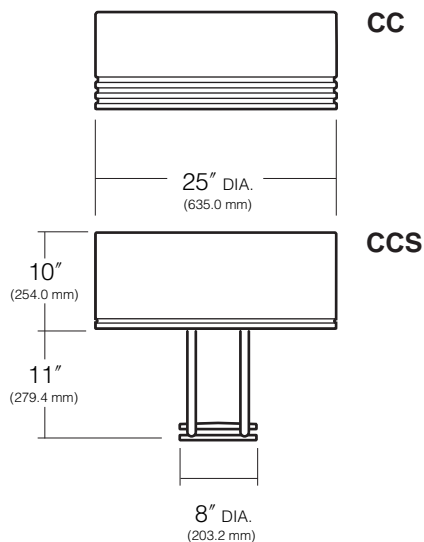

Housing: Spun aluminum. (Rollformed linear reveals; **CC:** Three equally spaced reveals, 1/2" wide, separated by 1/2" ribs, 1/4" deep. **CCS:** One 1/4" groove, 1/4" deep.) Sidewalls have a maximum 1° of taper, and are free of welds or fasteners. A rollformed aluminum flange is hemmed into the bottom providing support for the reflector module. An internal aluminum casting provides for mounting of the electrical module and support for the housing hinge.

Lens Frame and Yoke: One-piece cast aluminum lens frame is attached to the housing by a zinc plated cold rolled steel hinge with a stainless steel pin. Closure of the housing is by four self-retained stainless steel screws. A stainless steel self-locking stop arm is provided to hold the housing in the open position while servicing. A 3/16" thick clear flat tempered glass lens is fully gasketed by a one-piece extruded and vulcanized silicone gasket. Lens is retained in the frame by removable zinc plated steel clips. Lens frame is supported at four points by two aluminum U-shaped tubular arms cradled in a cast aluminum hub. Arms are welded to the lens frame, and welded to the hub along their longitudinal axis. Hub contains a field-splice attachment means: **FM** - Flush Mounting, **PT** - Pole Tenon mounting, or **DM** - Direct Mounting (See page 2 for complete descriptions).

Reflector Module: Specular Alzak® optical segments are rigidly mounted within a die-cast aluminum enclosure that attaches to the housing as a one-piece module. Reflectors are field rotatable in 90° increments. All sockets are factory prewired with a quick-disconnect plug for the ballast module. Wire penetrations to the socket are sealed by a silicone gasket to create a totally sealed optical chamber. The optical segments are positioned so that reflected light does not pass through the lamp arc tube. All HPS and PMH horizontal reflectors are equipped with a mogul base socket rated 4KV.

Electrical Module: All electrical components are UL and CSA recognized, mounted on a single plate and factory prewired with quick-disconnect plugs. Module attaches inside the housing using keyhole slots. All ballasts are high power factor with starting temperatures of -40°F. for HPS and -20°F. for PMH lamp modes.

Finish: Super TGIC thermoset polyester powder coat paint, 2.5 mil nominal thickness, applied over a titanated zirconium conversion coating; 5000 hour salt spray test endurance rating. Standard colors are Black, Dark Bronze, Light Gray, Stealth Gray™, Platinum Silver, or White. Custom colors are available.

CAUTION: Fixtures must be grounded in accordance with national, state and/or local electrical codes. Failure to do so may result in serious personal injury.

Listings and Ratings

UL cUL 1598*	CE	IP66 Rated	25C Ambient
Full Cut Off ² (Flat Glass Lens Only)			

*Suitable for wet locations

²Dark Sky Legislation Compliant

KIM LIGHTING RESERVES THE RIGHT TO CHANGE SPECIFICATIONS WITHOUT NOTICE.









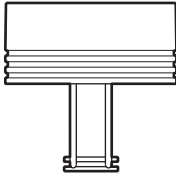

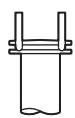

Type:

Job:

Page: 2 of 5



Standard Features

Mounting							
	EPA: 1.2	1.2	1.2				
	Cat. No.: <input type="checkbox"/> FM Flush Mount	<input type="checkbox"/> PT Pole Tenon Mount	<input type="checkbox"/> DM Direct Mount				
Pole Top Requirements:	4", 4½", 5", or 6" Dia.	2" Pipe-size Tenon (2⅜" O.D. x 4¾" L)	3.1" to 3.9" Dia.				
Fixture Cat. No. designates CC/CCS fixture and light distribution. See the Kim Site/Roadway Optical Systems Catalog for detailed information on reflector design and application.	Horizontal Lamp 						
	CC						
		CCS					
	Light Distribution:	Type I Full Cutoff	Type II Full Cutoff	Type III Full Cutoff	Type IV Forward Throw Full Cutoff	Type V Square Full Cutoff	
Cat. No.:	<input type="checkbox"/> CC25P1 <input type="checkbox"/> CCS25P1	<input type="checkbox"/> CC25P2 <input type="checkbox"/> CCS25P2	<input type="checkbox"/> CC25P3 <input type="checkbox"/> CCS25P3	<input type="checkbox"/> CC25P4 <input type="checkbox"/> CCS25P4	<input type="checkbox"/> CC25P5 <input type="checkbox"/> CCS25P5		

Type:

Job:

Page: 3 of 5

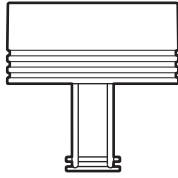

Standard Features

Electrical Module

HPS = High Pressure Sodium

PMH = Pulse Start Metal Halide

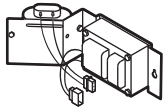

Lamp Watts	Lamp Type	Line Volts
400	HPS	277

Cat. Nos. for Electrical Modules available:

	High Pressure Sodium			
	<input type="checkbox"/> 150HPS120	<input type="checkbox"/> 250HPS120	<input type="checkbox"/> 400HPS120	
	<input type="checkbox"/> 150HPS208	<input type="checkbox"/> 250HPS208	<input type="checkbox"/> 400HPS208	
	<input type="checkbox"/> 150HPS240	<input type="checkbox"/> 250HPS240	<input type="checkbox"/> 400HPS240	
	<input type="checkbox"/> 150HPS277	<input type="checkbox"/> 250HPS277	<input type="checkbox"/> 400HPS277	
	<input type="checkbox"/> 150HPS347	<input type="checkbox"/> 250HPS347	<input type="checkbox"/> 400HPS347	
	<input type="checkbox"/> 150HPS480	<input type="checkbox"/> 250HPS480	<input type="checkbox"/> 400HPS480	
Lamp	ED-23½ Clear	ED-18 or ET-18 Clear	ED-18 or ET-18 Clear	
Socket	Mogul Base	Mogul Base	Mogul Base	
ANSI Ballast Type	S-55	S-50	S-51	
	Pulse Start Metal Halide ¹			
	<input type="checkbox"/> 250PMH120	<input type="checkbox"/> 320PMH120	<input type="checkbox"/> 350PMH120	<input type="checkbox"/> 400PMH120
	<input type="checkbox"/> 250PMH208	<input type="checkbox"/> 320PMH208	<input type="checkbox"/> 350PMH208	<input type="checkbox"/> 400PMH208
	<input type="checkbox"/> 250PMH240	<input type="checkbox"/> 320PMH240	<input type="checkbox"/> 350PMH240	<input type="checkbox"/> 400PMH240
	<input type="checkbox"/> 250PMH277	<input type="checkbox"/> 320PMH277	<input type="checkbox"/> 350PMH277	<input type="checkbox"/> 400PMH277
	<input type="checkbox"/> 250PMH347	<input type="checkbox"/> 320PMH347	<input type="checkbox"/> 350PMH347	<input type="checkbox"/> 400PMH347
	<input type="checkbox"/> 250PMH480	<input type="checkbox"/> 320PMH480	<input type="checkbox"/> 350PMH480	<input type="checkbox"/> 400PMH480
Lamp	ED-28 or BT-28 Clear	ED-28 Clear	ED-28 Clear	ED-28 Clear
Socket	Mogul Base	Mogul Base	Mogul Base	Mogul Base
ANSI Ballast Type	M-138	M-154 or M-132	M-131	M-135

NOTE: For lamp/ballast information outside of the U.S.A. and Canada, please consult your local Kim representative.

¹**CAUTION:** All manufacturers of metal halide lamps recommend turning them off for 15 minutes once per week when under continuous operation. This will reduce the risk of arc tube rupture at end of life. Also, color temperature may differ between manufacturers of metal halide lamps. See lamp manufacturers' specification sheets.

NOTE: Due to the Energy Independence and Security Act (EISA) of 2007, Kim Lighting can no longer supply probe start metal halide ballasts with its luminaires, effective January 1, 2009. Contact Kim Lighting for availability of replacement ballasts for warranty service claims.

(Visit www.aboutlightingcontrols.org or the Library of Congress website for more details).

Finish

Super TGIC powder coat paint over a titanated zirconium conversion coating.

Color: Black Dark Bronze Light Gray Stealth Gray™ Platinum Silver White Custom Color²
 Cat. No.: BL DB LG SG PS WH CC

²Custom colors subject to additional charges, minimum quantities and extended lead times. Consult representative. Custom color description: _____

Type:

Job:

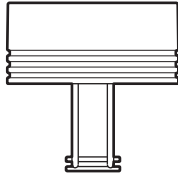

Optional Features

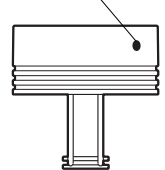
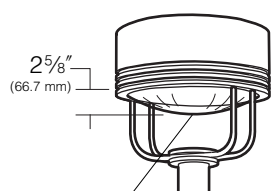
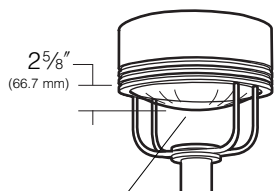
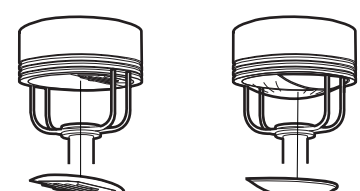
<p>Photocell Cat. No. (See right) <input type="checkbox"/> No Option</p>	<p>Factory installed photocell inside housing with a fully gasketed sensor on the side wall.</p> <table border="0"> <tr> <td>Cat. No.</td> <td>Line Volts:</td> <td>Cat. No.</td> <td>Line Volts:</td> </tr> <tr> <td><input type="checkbox"/> A-30</td> <td>120V</td> <td><input type="checkbox"/> A-33</td> <td>277V</td> </tr> <tr> <td><input type="checkbox"/> A-31</td> <td>208V</td> <td><input type="checkbox"/> A-35</td> <td>347V</td> </tr> <tr> <td><input type="checkbox"/> A-32</td> <td>240V</td> <td><input type="checkbox"/> A-34</td> <td>480V</td> </tr> </table>	Cat. No.	Line Volts:	Cat. No.	Line Volts:	<input type="checkbox"/> A-30	120V	<input type="checkbox"/> A-33	277V	<input type="checkbox"/> A-31	208V	<input type="checkbox"/> A-35	347V	<input type="checkbox"/> A-32	240V	<input type="checkbox"/> A-34	480V	<p>Photocell Sensor</p> 
Cat. No.	Line Volts:	Cat. No.	Line Volts:															
<input type="checkbox"/> A-30	120V	<input type="checkbox"/> A-33	277V															
<input type="checkbox"/> A-31	208V	<input type="checkbox"/> A-35	347V															
<input type="checkbox"/> A-32	240V	<input type="checkbox"/> A-34	480V															
<p>Convex Glass Lens Cat. No. <input type="checkbox"/> CGL <input type="checkbox"/> No Option</p>	<p>The 3/16" thick clear convex tempered glass lens replaces standard flat glass lens. Provides increased lens presence and provides a subtle improvement in uniformity where pole spacing is extreme. Increases effectiveness of houseside shielding.</p>	 <p>Convex Glass Lens</p>																
<p>Polycarbonate Lens Cat. No. <input type="checkbox"/> L25 <input type="checkbox"/> No Option</p>	<p>Clear UV stabilized convex polycarbonate replaces standard flat glass lens, gasketed and integral with lens frame. 250 Watt maximum. 400 Watt HPS is allowable in locations where ambient air temperature will not exceed 85°F. during operation.</p> <p>CAUTION: Use only when vandalism is anticipated to be high. Useful life is limited by UV discoloration from sunlight and metal halide lamps.</p>	 <p>Polycarbonate Lens</p>																
<p>Houseside Lens Cat. No. (See right) <input type="checkbox"/> No Option</p>	<p>Fixtures with the standard flat glass lens are available with stamped aluminum louvers that pass streetside light and block houseside light, and a black panel added to the reflector to reduce houseside reflections. Fixtures with the optional convex glass lens are available with a formed aluminum shield that passes streetside light and blocks houseside light, and a black panel added to the reflector to reduce houseside reflections.</p> <p>NOTE: Recommended for use with clear lamps only.</p> <table border="0"> <tr> <td>Cat. No.</td> <td></td> </tr> <tr> <td><input type="checkbox"/> HS</td> <td>For use with Type II, III, or IV light distributions only.</td> </tr> <tr> <td><input type="checkbox"/> HSC</td> <td>For fixture with optional convex glass lens or polycarbonate lens. Not for use with Type V light distributions.</td> </tr> </table>	Cat. No.		<input type="checkbox"/> HS	For use with Type II, III, or IV light distributions only.	<input type="checkbox"/> HSC	For fixture with optional convex glass lens or polycarbonate lens. Not for use with Type V light distributions.	 <p>HS for flat lens</p> <p>HSC for convex lens or polycarbonate lens</p>										
Cat. No.																		
<input type="checkbox"/> HS	For use with Type II, III, or IV light distributions only.																	
<input type="checkbox"/> HSC	For fixture with optional convex glass lens or polycarbonate lens. Not for use with Type V light distributions.																	

Type:

Job:

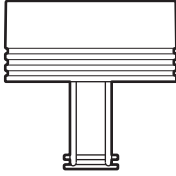

Optional Features

Neighbor Friendly Shield

Cat. No. **NFS**
 No Option

(Type IV only) Stamped internal shield and blocking panels are used to direct and redirect lighting into a forward throw distribution. The amount of light directed and redirected toward the back of the luminaire is dramatically reduced to create extremely low glare behind the pole. Only available on the Type IV reflectors.

Neighbor Friendly Shield for **flat** lens

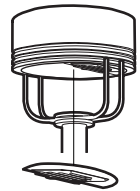

Accent Reveals

Cat. No. **(See right)**
 No Option

(For CC series only) Three aluminum bands riveted inside the housing reveals. Available in five standard Kim powder coat finishes. Custom colors available.

Accent Reveals

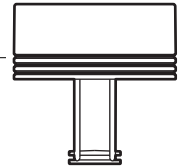

Color: Black Dark Bronze Light Gray Stealth Gray™ Platinum Silver White Custom Colors¹
 Cat. No.: **BL-REV** **DB-REV** **LG-REV** **SG-REV** **PS-REV** **WH-REV** **CC-REV**

¹Custom colors subject to additional charges, minimum quantities and extended lead times. Consult representative. Custom color description: _____