

Type:
Job:
Catalog number:

Approvals:

/ / /
 Mtg. Fixture Electrical Module Finish Options
 See page 2 See page 3 See pages 4-6

Date:
Page: 1 of 6

Select pole from Kim Arms and Poles Selection Guide. If pole is provided by others indicate O.D. for arm fitting..

Specifications

25" Diameter
 150 to 400 Watt

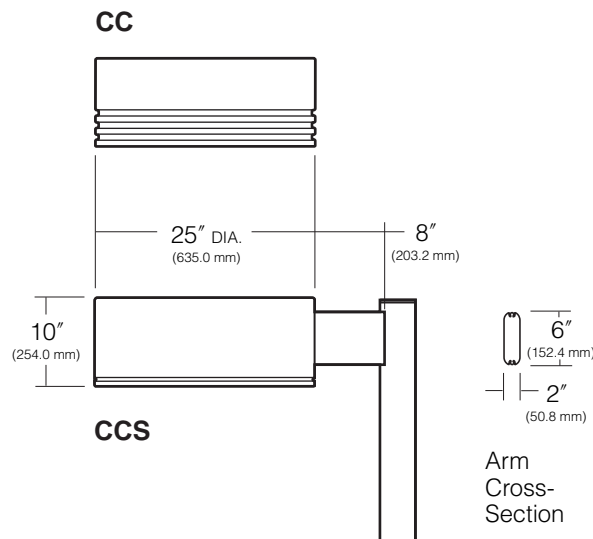

Housing: Spun aluminum. (Rollformed linear reveals; **CC:** Three equally spaced reveals, 1/2" wide, separated by 1/2" ribs, 1/4" deep. **CCS:** One 1/4" groove, 1/4" deep.) Sidewalls have a maximum 1° of taper, and are free of welds or fasteners. A rollformed aluminum flange is hemmed into the bottom providing support for the reflector module. An internal aluminum casting provides for mounting of the electrical module plus reinforcing for side-arm mounting of the fixture.

Lens Frame Assembly: One-piece cast aluminum lens frame is attached to the housing by a zinc plated cold rolled steel hinge with a stainless steel pin. Closure is by four self-retained stainless steel screws. A stainless steel self-locking stop arm is provided to hold the lens frame in the open position while servicing. A 3/16" thick clear flat tempered glass lens is fully gasketed by a one-piece extruded and vulcanized silicone gasket. Lens is retained in the frame by removable zinc plated steel clips.

Standard Arm Mounting: Arm is one-piece extruded aluminum with internal bolt guides and fully radiussed top and bottom. Luminaire-to-pole attachment is by internal draw bolts, and includes a pole reinforcing plate with wire strain relief. Arm is circular cut to mate with specified round pole.

Reflector Module: Specular Alzak® optical segments are rigidly mounted within a die-cast aluminum enclosure that attaches to the housing as a one-piece module. Reflectors are field rotatable in 90° increments. All sockets are factory prewired with a quick-disconnect plug for the ballast module. Wire penetrations to the socket are sealed by a silicone gasket to create a totally sealed optical chamber. The optical segments are positioned so that reflected light does not pass through the lamp arc tube. All HPS and PMH horizontal reflectors are equipped with a mogul base socket rated 4KV or 5KV.

Electrical Module: All electrical components are UL and CSA recognized, mounted on a single plate and factory prewired with quick-disconnect plugs. Module attaches inside the housing using keyhole slots. All ballasts are high power factor with starting temperatures of -40°F. for HPS and -20°F. for PMH lamp modes.

Finish/Color: Finish is Super TGIC thermoset polyester powder coat paint, 2.5 mil nominal thickness, applied over a titanated zirconium conversion coating; 5000 hour salt spray test endurance rating. Standard colors are Black, Dark Bronze, Light Gray, Stealth Gray™, Platinum Silver, or White. Custom colors are available.

Caution: Fixtures must be grounded in accordance with national, state and/or local electrical codes. Failure to do so may result in serious personal injury.

Listings and Ratings

UL cUL 1598*	CE	IP66 Rated	25C Ambient
Full Cut Off ² (Flat Glass Lens Only)			

*Suitable for wet locations

²Dark Sky Legislation Compliant

KIM LIGHTING RESERVES THE RIGHT TO CHANGE SPECIFICATIONS WITHOUT NOTICE.



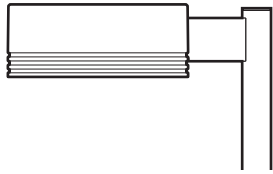

Type:

Job:

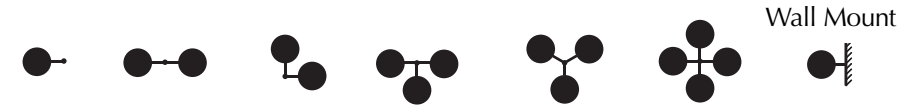
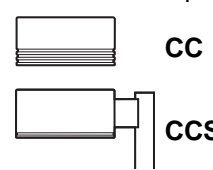

Standard Features

<p>Mounting 3Y configuration is available for round poles only.</p>	<p>Plan View:</p>  <p>EPA: 1.5 3.0 2.7 4.3 4.3 4.9 —</p> <p>Cat. No.: <input type="checkbox"/> 1A <input type="checkbox"/> 2B <input type="checkbox"/> 2L <input type="checkbox"/> 3T <input type="checkbox"/> 3Y <input type="checkbox"/> 4C <input type="checkbox"/> 1W</p>
<p>Fixture Cat. No. designates CC/CCS fixture and light distribution. See the Kim Site/Roadway Optical Systems Catalog for detailed information on reflector design and application.</p>	<p>Horizontal Lamp</p>  <p>Light Distribution:</p>  <p> Type I Type II Type III Type IV Type V</p> <p> Full Cutoff Full Cutoff Full Cutoff Forward Throw Full Cutoff Square Full Cutoff</p> <p>Cat. No.: <input type="checkbox"/> CC25A1 <input type="checkbox"/> CC25A2 <input type="checkbox"/> CC25A3 <input type="checkbox"/> CC25A4 <input type="checkbox"/> CC25A5</p> <p> <input type="checkbox"/> CCS25A1 <input type="checkbox"/> CCS25A2 <input type="checkbox"/> CCS25A3 <input type="checkbox"/> CCS25A4 <input type="checkbox"/> CCS25A5</p>

Type:

Job:

Page: 3 of 6

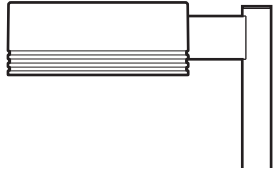

Standard Features

Electrical Module

HPS = High Pressure Sodium

PMH = Pulse Start Metal Halide

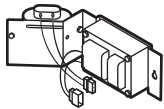

Lamp Watts	Lamp Type	Line Volts
400	HPS	277

Cat. Nos. for Electrical Modules available:

	High Pressure Sodium			
	<input type="checkbox"/> 150HPS120	<input type="checkbox"/> 250HPS120	<input type="checkbox"/> 400HPS120	
	<input type="checkbox"/> 150HPS208	<input type="checkbox"/> 250HPS208	<input type="checkbox"/> 400HPS208	
	<input type="checkbox"/> 150HPS240	<input type="checkbox"/> 250HPS240	<input type="checkbox"/> 400HPS240	
	<input type="checkbox"/> 150HPS277	<input type="checkbox"/> 250HPS277	<input type="checkbox"/> 400HPS277	
	<input type="checkbox"/> 150HPS347	<input type="checkbox"/> 250HPS347	<input type="checkbox"/> 400HPS347	
	<input type="checkbox"/> 150HPS480	<input type="checkbox"/> 250HPS480	<input type="checkbox"/> 400HPS480	
Lamp	ED-23 1/2 Clear	ED-18 or ET-18 Clear	ED-18 or ET-18 Clear	
Socket	Mogul Base	Mogul Base	Mogul Base	
ANSI Ballast Type	S-55	S-50	S-51	
	Pulse Start Metal Halide ¹			
	<input type="checkbox"/> 250PMH120	<input type="checkbox"/> 320PMH120	<input type="checkbox"/> 350PMH120	<input type="checkbox"/> 400PMH120
	<input type="checkbox"/> 250PMH208	<input type="checkbox"/> 320PMH208	<input type="checkbox"/> 350PMH208	<input type="checkbox"/> 400PMH208
	<input type="checkbox"/> 250PMH240	<input type="checkbox"/> 320PMH240	<input type="checkbox"/> 350PMH240	<input type="checkbox"/> 400PMH240
	<input type="checkbox"/> 250PMH277	<input type="checkbox"/> 320PMH277	<input type="checkbox"/> 350PMH277	<input type="checkbox"/> 400PMH277
	<input type="checkbox"/> 250PMH347	<input type="checkbox"/> 320PMH347	<input type="checkbox"/> 350PMH347	<input type="checkbox"/> 400PMH347
	<input type="checkbox"/> 250PMH480	<input type="checkbox"/> 320PMH480	<input type="checkbox"/> 350PMH480	<input type="checkbox"/> 400PMH480
Lamp	ED-28 or BT-28 Clear	ED-28 Clear	ED-28 Clear	ED-28 Clear
Socket	Mogul Base	Mogul Base	Mogul Base	Mogul Base
ANSI Ballast Type	M-138	M-154 or M-132	M-131	M-135

NOTE: For lamp/ballast information outside of the U.S.A. and Canada, please consult your local Kim representative.

CAUTION: All manufacturers of metal halide lamps recommend turning them off for 15 minutes once per week when under continuous operation. This will reduce the risk of arc tube rupture at end of life. Also, color temperature may differ between manufacturers of metal halide lamps. See lamp manufacturers' specification sheets.

NOTE: Due to the Energy Independence and Security Act (EISA) of 2007, Kim Lighting can no longer supply probe start metal halide ballasts with its luminaires, effective January 1, 2009. Contact Kim Lighting for availability of replacement ballasts for warranty service claims.

(Visit www.aboutlightingcontrols.org or the Library of Congress website for more details).

Finish

Super TGIC powder coat paint over a titanated zirconium conversion coating.

Color: Black Dark Bronze Light Gray Stealth Gray™ Platinum Silver White Custom Color²
 Cat. No.: BL DB LG SG PS WH CC

²Custom colors subject to additional charges, minimum quantities and extended lead times. Consult representative. Custom color description: _____

Type:

Job:

Page: 4 of 6

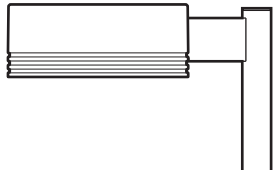

Optional Features

Wall Mounting

- Cat. No. **1W**
 No Option

Select from Mounting on page 2.

Wall Mount: A cast mounting plate of 356 alloy, low-copper (<0.6% Cu) aluminum, is mounted to the wall with bolts (by others). Fixture and arm are mounted to a cast 356 alloy aluminum cover plate before attaching to the wall mounting plate. The fixture-arm-cover plate assembly is hooked to the wall mounting plate, and secured with stainless steel screws provided. After mounting to the wall, field splices are made at the opening in the cover plate, then covered by a cast 356 alloy aluminum plate that blends with the cover plate design. Complete fixture-arm-cover plate assembly can therefore be mounted before field splices are made. Cover plate is finished to match arm and fixture powder coat color.

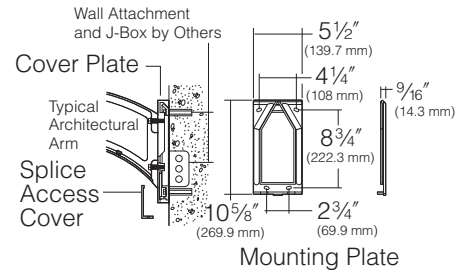

CAUTION: Structural integrity of mounting plate attachment to wall is by others.

Photocell

- Cat. No. **(See right)**
 No Option

Factory installed photocell inside housing with a fully gasketed sensor on the side wall. For multiple fixture mountings, one fixture is supplied with a photocell to operate the others. (Exception: Four 400 watt fixtures where two fixtures will have photocells.)

Cat. No.	Line Volts
<input type="checkbox"/> A-30	120V
<input type="checkbox"/> A-31	208V
<input type="checkbox"/> A-32	240V
<input type="checkbox"/> A-33	277V
<input type="checkbox"/> A-35	347V
<input type="checkbox"/> A-34	480V
<input type="checkbox"/> 2A-30	120V
<input type="checkbox"/> 2A-31	208V
<input type="checkbox"/> 2A-32	240V
<input type="checkbox"/> 2A-33	277V
<input type="checkbox"/> 2A-35	347V
<input type="checkbox"/> 2A-34	480V

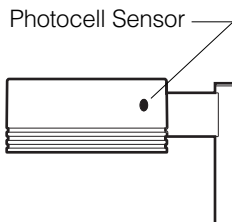

Mounting (see page 2)
 * Fixture with photocell receptacle
 s slave unit(s)

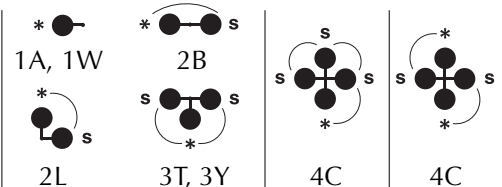

Allowable wattage per fixture: 150-400W | 150-250W | 400W

Convex Glass Lens

- Cat. No. **CGL**
 No Option

The 3/16" thick clear convex tempered glass lens replaces the standard flat glass lens. Provides increased lens presence and provides a subtle improvement in uniformity where pole spacing is extreme. Increases effectiveness of houseside shielding.

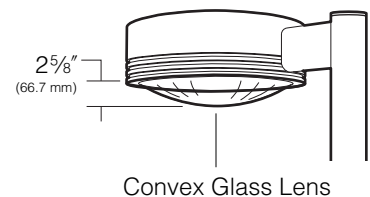

Convex Glass Lens

Polycarbonate Lens

- Cat. No. **L25**
 No Option

Clear UV stabilized convex polycarbonate replaces standard flat glass lens, gasketed and integral with lens frame. 250 Watt maximum. 400 Watt HPS is allowable in locations where ambient air temperature will not exceed 85°F. during operation.

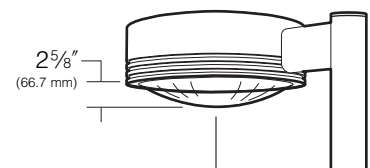

Polycarbonate Lens

Type:

Job:

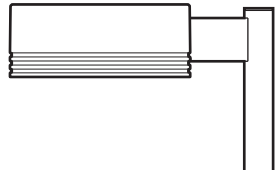

Optional Features

Houseside Shield

Cat. No. (See right)
 No Option

Fixtures with the standard flat glass lens are available with stamped aluminum louvers that pass streetside light and block houseside light, and a black panel added to the reflector to reduce houseside reflections. Fixtures with the optional convex glass lens are available with a formed aluminum shield that passes streetside light and blocks houseside light, and a black panel added to the reflector to reduce houseside reflections.

NOTE: Recommended for use with clear lamps only.

Cat. No.

HS For use with Types II, III, or IV distributions only.

HSC For fixtures with optional convex glass lens or polycarbonate lens. Not for use with Type V light distributions.

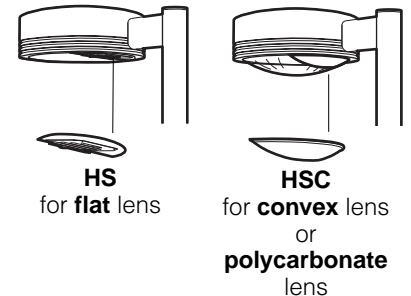

Neighbor Friendly Shield

Cat. No. **NFS**
 No Option

(Type IV only) Stamped internal shield and blocking panels are used to direct and redirect lighting into a forward throw distribution. The amount of light directed and redirected toward the back of the luminaire is dramatically reduced to create extremely low glare behind the pole. Only available on the Type IV reflectors.



Vertical Slipfitter Mounts

Cat. No. includes Mounting.
 Cat. No. (See right)
 No Option

Allows fixture with standard support arm to be mounted to steel poles having a 2" pipe-size steel tenon (2 3/8" O.D. x 4 1/2" min. length). 4" round or square cast aluminum with flush cap, secured by four 3/8" stainless steel set point allen screws. Pole tenon must be field drilled at one set screw location to insure against fixture rotation. Finished to match fixture.

NOTE: 3Y only available on round slipfitter.

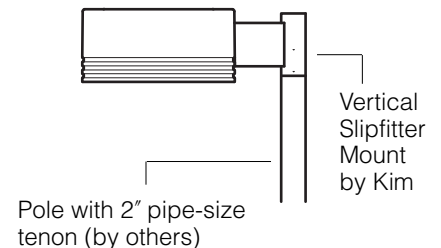

Cat. No.

- VSF-1A**
- VSF-2B**
- VSF-2L**
- VSF-3T**
- VSF-3Y**
- VSF-4C**



Round

Stainless steel set screws

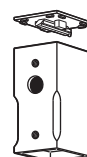

Square

Cat. No.

- SVSF-1A**
- SVSF-2B**
- SVSF-2L**
- SVSF-3T**
- SVSF-4C**

Mounting Configuration

- 1A - single arm mount
- 2B - 2 at 180°
- 2L - 2 at 90°
- 3T - 3 at 90°
- 3Y - 3 at 120°
- 4C - 4 at 90°

Support Arm

Cat. No. (See right)
 No Option

Note: Refer to Kim Lighting's Architectural Arms Catalog for complete details.

Arm View:



Swept Solid Arm



Swept Hollow Arm



Upsweep Solid Arm



Upsweep Hollow Arm

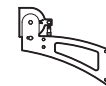

Uplift Adjustable Aluminum Arm



Uplift Adjustable Stainless Steel Arm

Cat. No.: **AA01** **AA03** **AA05** **AA07** **AA09** **AA11**



Type:

Job:

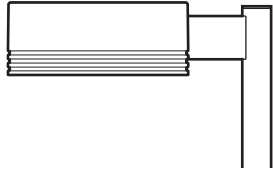

Optional Features

Horizontal Slipfitter Mount

Cat. No. HSF
 No Option

Replaces standard mounting arm with a slipfitter which allows **CC/CCS** Arm Mount model to be mounted to a horizontal pole davit-arm with 2" pipe-size mounting end (2 3/8" O.D.). Cast aluminum clamp-type slipfitter with set screw anti-rotation lock. Bolts to housing from inside the electrical compartment using mounting holes for the standard support arm. Davit-arm must be field drilled at a set screw location to insure against fixture rotation. Finished to match fixture and arm.

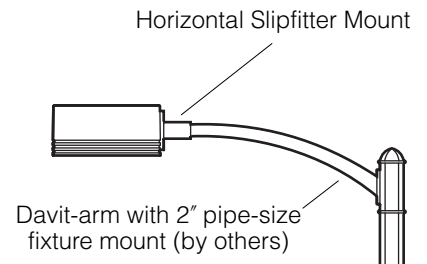

Accent Reveals

Cat. No. (See right)
 No Option

(For CC series only) Three aluminum bands riveted inside the housing reveals. Available in five standard Kim powder coat finishes. Custom colors available.

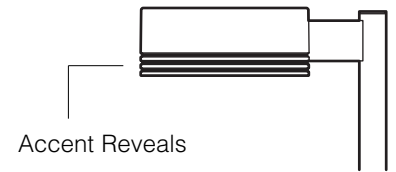

Color: Black Dark Bronze Light Gray Stealth Gray™ Platinum Silver White Custom Colors¹
Cat. No.: BL-REV DB-REV LG-REV SG-REV PS-REV WH-REV CC-REV

¹Custom colors subject to additional charges, minimum quantities and extended lead times. Consult representative. Custom color description: _____