



KIM LIGHTING

AE 21" Era[®] Acorn Series

The Era[®] Collection

revision 11/3/10 • ae21.pdf

Type:
Job:
Catalog number:

_____ / _____ / _____ / _____ / _____
Mtg Fixture Electrical Module Finish Options See pages 2-3 See pages 4-5
_____ Pole* _____

Approvals:

Date:
Page: 1 of 5

*Select pole from Kim Arms and Poles Selection Guide. If pole is provided by others indicate O.D. for arm fitting.

Specifications

AE21
21" Diameter
150 to 400 Watt

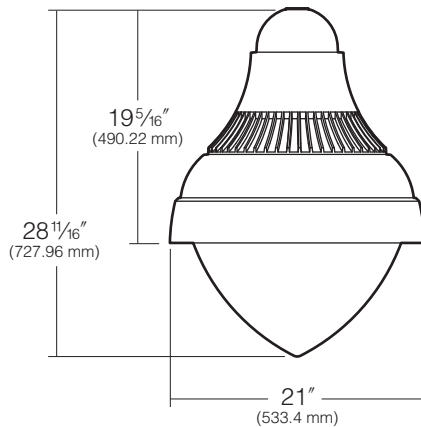

Housing: One-piece die-cast, low copper (<0.6% Cu) aluminum alloy component with integral cooling fins.

Lens Frame and Lens: One-piece die-cast, low copper (<0.6% Cu) aluminum alloy. Stainless steel hinges provided for attachment to housing. A single stainless steel thumb latch is provided for toolless entry and is concealed from normal view. The high temperature rated 3/16" thick clear injection molded acrylic acorn enclosure, UV stabilized (optional Lexan[®]) seals against the reflector flange by a one-piece extruded silicone gasket with fused seam, to produce a fully sealed optical chamber (IP66).

Mounting: Stainless steel bolts are provided to attach the luminaire to mounting arms.

Reflector Module: Specular Alzak[®] optical segments are rigidly mounted within a one-piece die-cast, low copper (<0.6% Cu) aluminum alloy enclosure, which attaches to the housing as a one-piece module. Reflectors are field rotatable in 90° increments. All sockets are factory prewired with a quick-disconnect plug for the ballast module, with wires passing through a silicone gasket to maintain sealed optical chamber integrity. The optical segments are positioned so that reflected light does not pass through the lamp arc tube to achieve maximum lamp output.

Socket: Equipped with a mogul base socket rated 4KV and has a silicone lamp stabilizer.

Electrical Module: All electrical components are UL and CSA recognized, mounted on a single plate and factory prewired with quick-disconnect plugs for attachment to the incoming wires and the socket wires. The module attaches inside the housing using keyhole slots. All ballasts are high power factor with starting temperatures of -40°F for HPS and -20°F for PMH lamp modes.

Finish/Color: Finish is Super TGIC thermoset polyester powder coat paint, 2.5 mil nominal thickness, applied over a titanated zirconium conversion coating; A.S.T.M. 2500 hour salt spray test endurance rating. Standard colors are Black, Dark Bronze, Light Gray, Stealth Gray[™], Platinum Silver, or White. Custom colors are available.

CAUTION: Fixtures must be grounded in accordance with national, state, and/or local codes. Failure to do so may result in serious personal injury.

Listings and Ratings

UL cUL 1598 ¹	IP66 Rated	25C Ambient
Cutoff (Horizontal Lamp) / Semi Cutoff (Vertical Lamp)		

¹Suitable for wet locations

KIM LIGHTING RESERVES THE RIGHT TO CHANGE SPECIFICATIONS WITHOUT NOTICE.



Type:

Job:

Page: 3 of 5



Standard Features

Electrical Module

PMH = Pulse Start
Metal Halide

HPS = High Pressure
Sodium

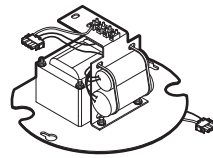

Lamp Watts	Lamp Type	Line Volts
175	PMH	277

NOTE: For lamp/ballast information outside of the U.S. and Canada, please consult your local Kim representative.

Cat. Nos. for Electrical Modules available:

Pulse Start Metal Halide

<input type="checkbox"/> 175PMH120 ¹	<input type="checkbox"/> 250PMH120	<input type="checkbox"/> 400PMH120
<input type="checkbox"/> 175PMH208 ¹	<input type="checkbox"/> 250PMH208	<input type="checkbox"/> 400PMH208
<input type="checkbox"/> 175PMH240 ¹	<input type="checkbox"/> 250PMH240	<input type="checkbox"/> 400PMH240
<input type="checkbox"/> 175PMH277 ¹	<input type="checkbox"/> 250PMH277	<input type="checkbox"/> 400PMH277
<input type="checkbox"/> 175PMH347 ¹	<input type="checkbox"/> 250PMH347	<input type="checkbox"/> 400PMH347
<input type="checkbox"/> 175PMH480 ¹	<input type="checkbox"/> 250PMH480	<input type="checkbox"/> 400PMH480

High Pressure Sodium

<input type="checkbox"/> 150HPS120	<input type="checkbox"/> 250HPS120	<input type="checkbox"/> 400HPS120
<input type="checkbox"/> 150HPS208	<input type="checkbox"/> 250HPS208	<input type="checkbox"/> 400HPS208
<input type="checkbox"/> 150HPS240	<input type="checkbox"/> 250HPS240	<input type="checkbox"/> 400HPS240
<input type="checkbox"/> 150HPS277	<input type="checkbox"/> 250HPS277	<input type="checkbox"/> 400HPS277
<input type="checkbox"/> 150HPS347	<input type="checkbox"/> 250HPS347	<input type="checkbox"/> 400HPS347
<input type="checkbox"/> 150HPS480	<input type="checkbox"/> 250HPS480	<input type="checkbox"/> 400HPS480

Lamp	ED-17, Clear	ED-28, Clear	ED-28, Clear	ED-23 1/2, Clear	E-18, Clear	E-18, Clear
Socket	Mogul Base	Mogul Base	Mogul Base	Mogul Base	Mogul Base	Mogul Base
ANSI Ballast Type	M-137	M-138	M-135	S-55	S-50	S-51

¹175PMH lamp for use in vertical lamp reflector systems (V3 and V5) only.

NOTE: Due to the Energy Independence and Security Act (EISA) of 2007, Kim Lighting can no longer supply probe start metal halide ballasts with its luminaires, effective January 1, 2009. Contact Kim Lighting for availability of replacement ballasts for warranty service claims. (Visit www.aboutlightingcontrols.org or the Library of Congress website for more details).

Finish

Super TGIC powder coat paint over a titanated zirconium conversion coating.

Color: Black Dark Bronze Light Gray Stealth Gray™ Platinum Silver White Custom Color²
 Cat. No.: **BL** **DB** **LG** **SG** **PS** **WH** **CC**

²Custom colors subject to additional charges, minimum quantities and extended lead times. Consult representative. Custom color description: _____

Type:

Job:

Page: 4 of 5

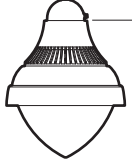
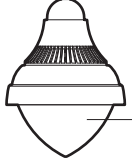
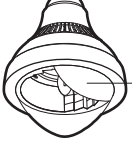
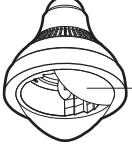
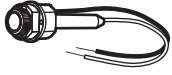

Optional Features

<p>Photocell Cat. No. (See right) <input type="checkbox"/> No Option</p>	<p>Factory installed fully gasketed sensor.</p> <table border="0"> <tr> <td>Cat. No.</td> <td>Line Volts</td> <td>Cat. No.</td> <td>Line Volts</td> </tr> <tr> <td><input type="checkbox"/> A-30</td> <td>120V</td> <td><input type="checkbox"/> A-33</td> <td>277V</td> </tr> <tr> <td><input type="checkbox"/> A-31</td> <td>208V</td> <td><input type="checkbox"/> A-35</td> <td>347V</td> </tr> <tr> <td><input type="checkbox"/> A-32</td> <td>240V</td> <td><input type="checkbox"/> A-34</td> <td>480V</td> </tr> </table>	Cat. No.	Line Volts	Cat. No.	Line Volts	<input type="checkbox"/> A-30	120V	<input type="checkbox"/> A-33	277V	<input type="checkbox"/> A-31	208V	<input type="checkbox"/> A-35	347V	<input type="checkbox"/> A-32	240V	<input type="checkbox"/> A-34	480V	 <p>Photocell Control</p>
Cat. No.	Line Volts	Cat. No.	Line Volts															
<input type="checkbox"/> A-30	120V	<input type="checkbox"/> A-33	277V															
<input type="checkbox"/> A-31	208V	<input type="checkbox"/> A-35	347V															
<input type="checkbox"/> A-32	240V	<input type="checkbox"/> A-34	480V															
<p>Lexan[®] Enclosure Cat. No. <input type="checkbox"/> LS <input type="checkbox"/> No Option</p>	<p>Lexan[®] enclosure replaces standard acrylic enclosure.</p>	 <p>Lexan[®] Enclosure</p>																
<p>Houseside Shield Cat. No. <input type="checkbox"/> HS <input type="checkbox"/> No Option</p>	<p>Recommended for use with clear lamps only. Effectiveness is reduced for coated lamps. Not for use with Type V (H5 - horizontal lamp) or symmetric (V5 - vertical lamp) light distributions.</p>	 <p>Houseside Shield</p>																
<p>Neighbor Friendly Shield Cat. No. <input type="checkbox"/> NFS <input type="checkbox"/> No Option</p>	<p>(Type IV only) Stamped internal shield and blocking panels are used to direct and redirect lighting into a forward throw distribution. The amount of light directed and redirected toward the back of the luminaire is dramatically reduced to create extremely low glare behind the pole. Only available on the Type IV reflectors.</p>	 <p>Neighbor Friendly Shield</p>																
<p>Fusing Cat. No. (See right) <input type="checkbox"/> No Option</p>	<p>High temperature fuse holders factory installed inside the fixture housing.</p> <table border="0"> <tr> <td>Line Volts:</td> <td>120V</td> <td>208V</td> <td>240V</td> <td>277V</td> <td>347V</td> <td>480V</td> </tr> <tr> <td>Cat. No.:</td> <td><input type="checkbox"/> SF</td> <td><input type="checkbox"/> DF</td> <td><input type="checkbox"/> DF</td> <td><input type="checkbox"/> SF</td> <td><input type="checkbox"/> SF</td> <td><input type="checkbox"/> DF</td> </tr> </table>	Line Volts:	120V	208V	240V	277V	347V	480V	Cat. No.:	<input type="checkbox"/> SF	<input type="checkbox"/> DF	<input type="checkbox"/> DF	<input type="checkbox"/> SF	<input type="checkbox"/> SF	<input type="checkbox"/> DF	 <p>Single Fuse</p>		
Line Volts:	120V	208V	240V	277V	347V	480V												
Cat. No.:	<input type="checkbox"/> SF	<input type="checkbox"/> DF	<input type="checkbox"/> DF	<input type="checkbox"/> SF	<input type="checkbox"/> SF	<input type="checkbox"/> DF												
<p>Poles and Arms</p>	<p>See Kim Lighting's Arms and Poles Selection Guide for a complete selection of heritage style poles. Arm variations are shown on page 5.</p>																	

Type:

Job:

















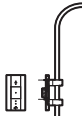



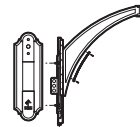

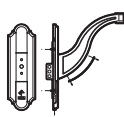

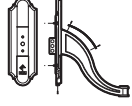

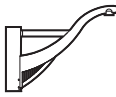
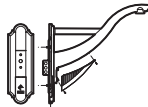

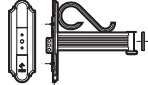
Arm Options

Arms

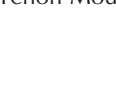
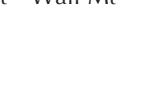
Note: Refer to Kim Lighting's Arms and Poles Selection Guide for complete details.

Mounting Orientation

- 1A
- 2B
- 3Y
- 4C

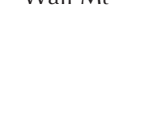
Post Top Crook¹			Side Pole Crook¹			Post Top Swept Cast Arm¹		
ARM	Tenon Mount	Wall Mt	ARM	Tenon Mount	Wall Mt	ARM	Tenon Mount	Wall Mt
		NA						NA
HA01L	HA01L-TM1		HA02L	HA02L-TM1 HA02L-TM2 HA02L-TM3 HA02L-TM4	HA02L-W	HA03L	HA03L-TM1 HA03L-TM2 HA03L-TM3 HA03L-TM4	
Side Pole Swept Cast Arm			Side Pole S-Shaped Up Cast Arm			Side Pole S-Shaped Down Cast Arm		
ARM	Tenon Mount	Wall Mt	ARM	Tenon Mount	Wall Mt	ARM	Tenon Mount	Wall Mt
								
HA11L	HA11L-TM1 HA11L-TM2 HA11L-TM3 HA11L-TM4	HA11L-W	HA12L	HA12L-TM1 HA12L-TM2 HA12L-TM3 HA12L-TM4	HA12L-W	HA13L	HA13L-TM1 HA13L-TM2 HA13L-TM3 HA13L-TM4	HA13L-W
Side Pole Neo-Classic Arm¹			Side Pole Ribbon Arm w/Top Scroll			Side Pole Ribbon Arm w/Top Gusset		
ARM	Tenon Mount	Wall Mt	ARM	Tenon Mount	Wall Mt	ARM	Tenon Mount	Wall Mt
								
HA14L	HA14L-TM1 HA14L-TM2 HA14L-TM3 HA14L-TM4	HA14L-W	HA31L	HA31L-TM1 HA31L-TM2 HA31L-TM3 HA31L-TM4	HA31L-W	HA33L	HA33L-TM1 HA33L-TM2 HA33L-TM3 HA33L-TM4	HA33L-W
Side Pole Ribbon Arm w/Top Brace			Side Pole Ribbon Arm w/Top Brace & Bottom Scroll			Side Pole Ribbon Arm w/Top Brace & Bottom Gusset		
ARM	Tenon Mount	Wall Mt	ARM	Tenon Mount	Wall Mt	ARM	Tenon Mount	Wall Mt
								
HA35L	HA35L-TM Consult Factory	HA35L-W Consult Factory	HA37L	HA37L-TM Consult Factory	HA37L-W Consult Factory	HA38L	HA38L-TM Consult Factory	HA38L-W Consult Factory

Arm Finial:

HAF2 - Traditional style finial available to close off mounting hub opposite the fixture.
¹Not available on arm where indicated.

