



**Type:**  
**Job:**  
**Catalog number:**

**Approvals:**

/                      /                      /                      /  
 Mtg. Fixture                      Electrical Module                      Finish                      Options  
 See page 2                      See page 3                      See page 4

**Date:**  
**Page: 1 of 4**

Select pole from Kim Pole Catalog. If pole is provided by others indicate O.D. for arm fitting.

## Specifications

**ACP27**  
750 to 1000 watt

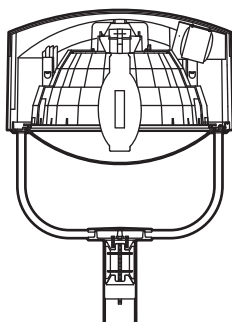
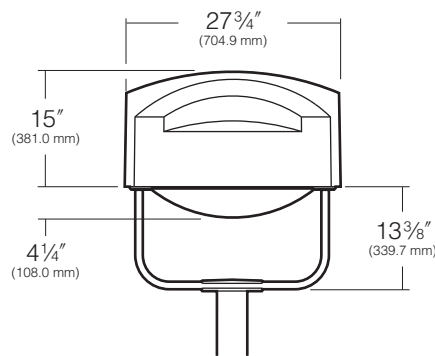

**Housing:** One-piece die-cast, low copper (<0.6% Cu) aluminum alloy. All hardware is stainless steel. A stainless steel self-locking stop-arm is provided to hold the housing in the up position while servicing.

**Lens Frame and Yoke:** One-piece die-cast, low copper (<0.6% Cu) aluminum alloy with 1" minimum thickness around the gasket flange for rigidity. Stainless steel hinge provided for attachment to the housing. Two stainless steel thumb latches are recessed into the side corners, concealed from normal view. The 3/16" thick clear flat or convex tempered glass lens seals against the reflector flange by a one-piece extruded silicone gasket with the ends fused to produce a continuous loop, eliminating gaps that allow the intrusion of foreign objects into the optical system. Lens frame is supported at four points by two aluminum U-shaped tubular arms cradled in a cast aluminum hub. Arms are welded to the lens frame, and welded to the hub along their longitudinal axis. Hub contains a field-splice compartment, a cast aluminum cover and one of the following pole attachment means:

**FM** - Flush Mounting by means of an expansion device activated by a single bolt within the splice compartment. Pole must have a plain-cut top.

**PT** - Pole Tenon mounting by means of a cast aluminum extension sleeve containing four recessed 3/8" stainless steel allen head set point screws. Pole must have a 2" pipe-size tenon (2 3/8" O.D. x 4 3/4" minimum length). Pole tenon must be field drilled at one set screw location to secure against fixture rotation.

**DM** - Direct mounting by means of a cast aluminum extension sleeve containing four recessed 3/8" stainless steel allen head set point screws. Pole must have a plain-cut top. 3.1" to 3.9" diameter. Pole must be field-drilled at one set screw location to secure against fixture rotation.

**Reflector Module:** Specular Alzak® optical segments are rigidly mounted within a die-cast, low copper (<0.6% Cu) aluminum alloy enclosure that attaches to the housing as a one-piece module. Reflectors are field rotatable in 90° increments. All sockets are factory prewired with a quick-disconnect plug for the ballast module. Wire penetrations to the socket are sealed by a silicone gasket to create a totally sealed optical chamber. The optical segments are positioned so that reflected light does not pass through the lamp arc tube. The socket is held in a heat sink die-cast segment and fastened to a multi-position plate set at the factory for "Wide" or "Medium" beam spread. The beam spread can be adjusted in the field with the simple removal of two screws and a turn of the socket brackets. "Narrow" beam reflectors are fixed and non-adjustable. All vertical reflectors are equipped with a mogul base socket rated 4KV or 5KV (750 & 1000 watt). All optical systems are interchangeable within the housing. 750 AND 1000 watt vertical lamps utilizes a lamp vibration stabilizer that braces the neck of the lamp with two-prong stainless steel clamp extending from the socket mount.

**Electrical Module:** All electrical components are UL and CSA recognized, mounted on a single plate and factory prewired with quick-disconnect plugs for attachment to the incoming wires and socket wires. The module attaches inside the housing using keyhole slots. All ballasts are high power factor with starting temperatures of -40°F. for HPS and -20°F. for MH lamp modes.

**Finish/Color:** Finish is Super TGIC thermoset polyester powder coat paint, 2.5 mil nominal thickness, applied over a titanated zirconium conversion coating; A.S.T.M. 2500 hour salt spray test endurance rating. Standard colors are Black, Dark Bronze, Light Gray, Stealth Gray™, Platinum Silver or White. Custom colors are available.

**Caution:** Fixtures must be grounded in accordance with national, state and/or local electrical codes. Failure to do so may result in serious personal injury.

**Post Top Mount with Vertical Lamp**

### Listings and Ratings

UL cUL 1598 <sup>1</sup>	IP66 Rated	25C Ambient
Cut Off <sup>2</sup> (CGL) / Full CutOff (Flat Glass Lens Only)		

<sup>1</sup>Suitable for wet locations

<sup>2</sup>Dark sky legislation compliant

KIM LIGHTING RESERVES THE RIGHT TO CHANGE SPECIFICATIONS WITHOUT NOTICE.



U.S. Patent D485,634











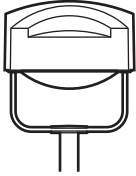





Type:

Job:

Page: 2 of 4



## Standard Features

<b>Mounting</b>				
<b>Fixture</b> Cat. No. designates <b>AC</b> fixture, light distribution and beam spread.  See the Kim Site / Roadway Optical Systems Catalog for detailed information on reflector design and application.	<b>Light Distribution:</b>   Convex Lens   Flat Lens	EPA: 2.1 Cat. No.: <input type="checkbox"/> <b>FM</b> Flush Mount Pole Top Requirements: 4", 4½", 5" or 6" Dia.	EPA: 2.1 Cat. No.: <input type="checkbox"/> <b>PT</b> Pole Tenon Mount Pole Top Requirements: 2" Pipe-size Tenon (2⅜" O.D. x 4¾" L)	EPA: 2.1 Cat. No.: <input type="checkbox"/> <b>DM</b> Direct Mount Pole Top Requirements: 3.1" to 3.9" Dia.
		W5  Wide Symmetric Square <input type="checkbox"/> <b>ACP27C.W5</b>	M5  Medium Symmetric Square <input type="checkbox"/> <b>ACP27C.M5</b>	N5  Narrow Symmetric Square n/a
		n/a	n/a	<input type="checkbox"/> <b>ACP27F.N5<sup>1</sup></b>
		W3  Wide Asymmetric <input type="checkbox"/> <b>ACP27C.W3</b>	M3  Medium Asymmetric <input type="checkbox"/> <b>ACP27C.M3</b>	N3  Narrow Asymmetric n/a
		n/a	n/a	<input type="checkbox"/> <b>ACP27F.N3<sup>1</sup></b>
		<sup>1</sup> ED37 Philips lamp required for Narrow Beam, Flat Lens models.		



Type:

Job:

Page: 3 of 4

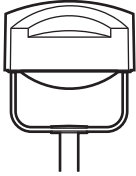

## Standard Features

### Electrical Module

**HPS** = High Pressure Sodium

**MH** = Metal Halide

**PMH** = Pulse Start Metal Halide

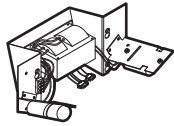

Lamp Watts    Lamp Type    Line Volts  
**750   HPS   277**

Cat. Nos. for Electrical Modules available:

#### High Pressure Sodium

- |   |  |
|---|--|
| <input type="checkbox"/> <b>750HPS120</b> | <input type="checkbox"/> <b>1000HPS120<sup>1</sup></b> |
| <input type="checkbox"/> <b>750HPS208</b> | <input type="checkbox"/> <b>1000HPS208<sup>1</sup></b> |
| <input type="checkbox"/> <b>750HPS240</b> | <input type="checkbox"/> <b>1000HPS240<sup>1</sup></b> |
| <input type="checkbox"/> <b>750HPS277</b> | <input type="checkbox"/> <b>1000HPS277<sup>1</sup></b> |
| <input type="checkbox"/> <b>750HPS347</b> | <input type="checkbox"/> <b>1000HPS347<sup>1</sup></b> |
| <input type="checkbox"/> <b>750HPS480</b> | <input type="checkbox"/> <b>1000HPS480<sup>1</sup></b> |

Lamp	BT-37, Clear	E-25 or ED-37 <sup>1</sup> , clear
Socket	Mogul Base	Mogul Base
ANSI Ballast Type	S-111	S-52

#### Metal Halide

- |   |
|---|
| <input type="checkbox"/> <b>1000MH120</b> |
| <input type="checkbox"/> <b>1000MH208</b> |
| <input type="checkbox"/> <b>1000MH240</b> |
| <input type="checkbox"/> <b>1000MH277</b> |
| <input type="checkbox"/> <b>1000MH347</b> |
| <input type="checkbox"/> <b>1000MH480</b> |

Lamp	BT-37, Clear
Socket	Mogul Base
ANSI Ballast Type	M-47

#### Pulse Start Metal Halide

- |   |  |
|---|--|
| <input type="checkbox"/> <b>750PMH120</b> | <input type="checkbox"/> <b>1000PMH120</b> |
| <input type="checkbox"/> <b>750PMH208</b> | <input type="checkbox"/> <b>1000PMH208</b> |
| <input type="checkbox"/> <b>750PMH240</b> | <input type="checkbox"/> <b>1000PMH240</b> |
| <input type="checkbox"/> <b>750PMH277</b> | <input type="checkbox"/> <b>1000PMH277</b> |
| <input type="checkbox"/> <b>750PMH347</b> | <input type="checkbox"/> <b>1000PMH347</b> |
| <input type="checkbox"/> <b>750PMH480</b> | <input type="checkbox"/> <b>1000PMH480</b> |

Lamp	BT-37, Clear	BT-37, Clear
Socket	Mogul Base	Mogul Base
ANSI Ballast Type	M-149	M-141

<sup>1</sup>ED37 Philips lamp required for Narrow Beam, Flat Lens models.

### Finish

Super TGIC powder coat paint over a titanated zirconium conversion coating.

Color:    Black    Dark Bronze    Light Gray    Stealth Gray™    Platinum Silver    White    Custom Color<sup>1</sup>  
Cat. No.:  **BL**     **DB**     **LG**     **SG**     **PS**     **WH**     **CC**

<sup>1</sup>Custom colors subject to additional charges, minimum quantities and extended lead times. Consult representative. Custom color description: \_\_\_\_\_



Type:

Job:

Page: 4 of 4

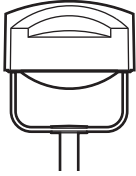

## Optional Features

### Photocell

Cat. No. (See right)  
 No Option

Factory installed photocell inside housing with a fully gasketed sensor on the side wall.

Cat. No.	Line Volts:	Cat. No.	Line Volts:
<input type="checkbox"/> <b>A-30</b>	120V	<input type="checkbox"/> <b>A-33</b>	277V
<input type="checkbox"/> <b>A-31</b>	208V	<input type="checkbox"/> <b>A-35</b>	347V
<input type="checkbox"/> <b>A-32</b>	240V	<input type="checkbox"/> <b>A-34</b>	480V

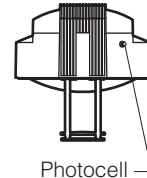

### Houseside Shield

Cat. No. (See right)  
 No Option

**(Types II, III, IV, and Asymmetric distributions only).** The cutoff horizontal reflectors are available with stamped aluminum louvers that pass streetside light and block houseside light, and a blackened panel added to the reflector to reduce houseside reflections. The vertical reflectors and horizontal reflectors with the optional convex glass lens are available with a formed aluminum shield that passes streetside light, and blocks houseside light, and a black anodized panel added to the reflector to reduce houseside reflections.



Houseside Shield for **flat** lens

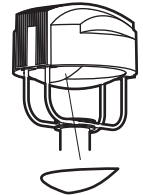

Houseside Shield for **convex** lens or polycarbonate lens

Cat. No.

- HS** For fixtures with flat lens and asymmetric light distribution only. Do not use with square light distribution.
- HSC** For fixtures with convex lens and asymmetric light distribution only. Do not use with square light distribution.

### Fusing

Cat. No. (See Right)  
 No Option

High temperature fuse holders factory installed inside the fixture housing.

Line Volts:	120V	208V	240V	277V	480V	347V
Cat. No.:	<input type="checkbox"/> <b>SF</b>	<input type="checkbox"/> <b>DF</b>	<input type="checkbox"/> <b>DF</b>	<input type="checkbox"/> <b>SF</b>	<input type="checkbox"/> <b>DF</b>	<input type="checkbox"/> <b>SF</b>